

**TEC**

TEC Electronic Cash Register

**MA-1300-100**

**Owner's Manual**



**TOKYO ELECTRIC CO., LTD.**



## TABLE OF CONTENTS

	Page
1. TO OUR CUSTOMERS .....	1
2. PRECAUTIONS .....	1
3. APPEARANCE AND NOMENCLATURE .....	2
4. MODE LOCK AND CLERK LOCKS .....	3
5. DISPLAY .....	5
6. KEYBOARD LAYOUT .....	7
7. FUNCTION OF EACH KEY .....	9
8. REGISTERING PROCEDURE AND RECEIPT SAMPLES .....	22
9. POWER FAILURE PROCESS .....	55
10. JOURNAL AND RECEIPT PAPER-END DETECTOR .....	55
11. ECR PRINTER MOTOR LOCK DETECTOR .....	55
12. READ (X) AND RESET (Z) REPORTS .....	56
13. PROGRAMMING OPERATIONS .....	64
14. VERIFICATION OF PROGRAMMED DATA .....	84
15. PAPER ROLL REPLACEMENT AND OTHER MAINTENANCE OPERATIONS .....	88
16. SPECIFICATIONS .....	92



# 1. TO OUR CUSTOMERS

Thank you for choosing the TEC electronic cash register MA-1300 series. This instruction manual provides a description of the functions and handling of this register and should be read carefully to ensure optimum performance. Since every consideration has been given to safety and reliability, there is no danger of damaging the machine by incorrect operation.

Please refer to this manual whenever you have any questions concerning the machine. This machine has been manufactured under strict quality control and should give you full satisfaction. However, if the machine is damaged during transit, or there are any unclear points in this manual, please contact your local TEC representative.

- The specifications described in this manual may be modified by TEC, if necessary.
- Be sure to keep this manual for future reference.

## 2. PRECAUTIONS

The ECR is a precision machine. Please handle it carefully considering the following guidelines.

### REMARKS ON THE LOCATION

- Place it where no unusual temperature changes are expected.
- Place it on a flat and level surface with little dust, humidity, vibration, etc.
- Keep it away from water sources.
- Do not use it in direct sunlight for a long time.
- Ensure proper ventilation so that the machine is not exposed to excessive heat.
- Be certain to connect a grounding wire to prevent the generation of static electricity and noise troubles. Never share the same power outlet with many other electric appliances.

### REMARKS ON OPERATING THE ECR

- The keys on the keyboard function with a light touch. Avoid pressing the keys too hard.
- Do not handle the machine with wet hands, since this may cause electrical malfunctions and corrosion of parts.
- Do not apply thinner, benzine, or other volatile materials to the cabinet or other plastic parts. Such liquids will cause discoloration or deterioration of the cover. If dirty, wipe off with a piece of cloth soaked in a neutral detergent and wrung out thoroughly.
- Ask your TEC representative to provide periodic maintenance to ensure the optimum performance of the machine.
- As for other operations, follow the instructions in this manual.

### 3. APPEARANCE AND NOMENCLATURE

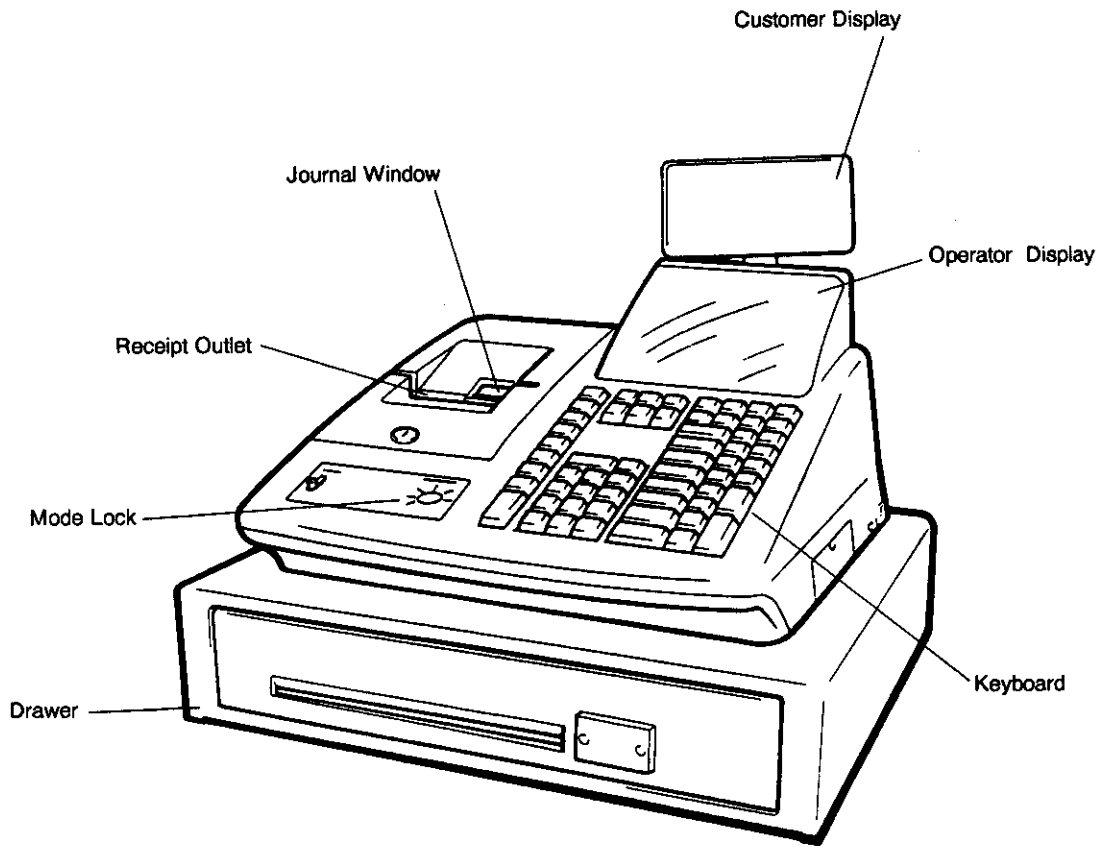

# 4. MODE LOCK AND CLERK LOCKS

## 4-1 MODE LOCK

(POSITION) (FUNCTION)

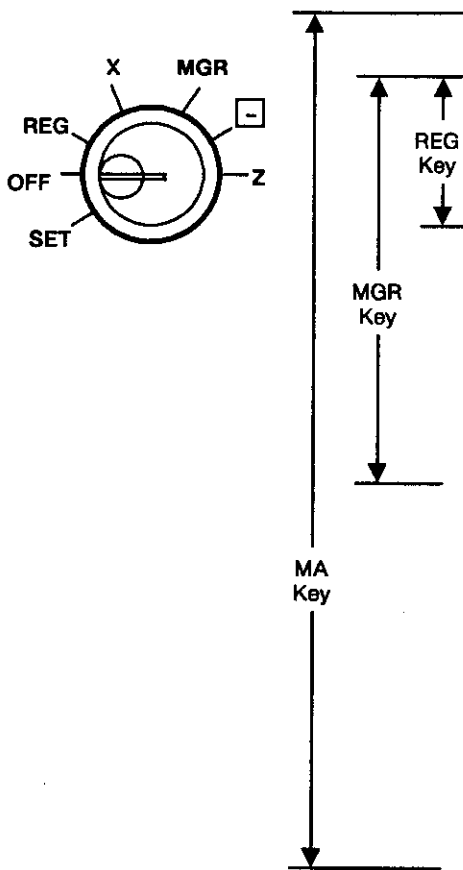

- SET . . . .** In this position, the register will allow programming operations.
- OFF . . . .** The register operations are locked when the Mode Lock is in this position.
- REG . . . .** Normal cash register operations are carried out in this mode. However the operations requiring a Manager Intervention cannot be performed in this mode.
- X . . . . .** The sale totals in memory can be read and the programmed data can be verified in this position.
- MGR . . . .** This position allows to register all normal cash register operations to be carried out in the "REG" mode and the operations requiring a Manager Intervention.
- ☐ . . . . .** This is the "Negative Mode", which automatically processes all the entries in the reverse way, i.e. positive items into negative, and the negative into positive. It is usually used to return or cancel all the items once purchased in a sale in the "REG" or "MGR" mode.
- Z . . . . .** All the resettable totals and their respective counters in memory will be read and reset in this position.



**REG Key:**

The REG Key is used by the cashier or clerk who operates the register. This key can access the positions of **OFF** and **REG**.



**MGR Key:**

The MGR Key is used by the store manager or a person authorized by the manager. This key can access the positions of **OFF**, **REG**, **X**, and **MGR**.

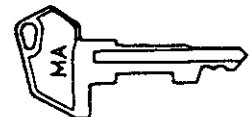

**MA Key:**

The MA Key is used by the store manager who will daily supervise the collection of money and the printout of transactions recorded by the register. It is also used by the programmer. This key can access the positions of **SET**, **OFF**, **REG**, **X**, **MGR**, **☐**, and **Z**.

The keys may be inserted or pulled out at the "OFF" or "REG" position.

## 4-2 CLERK-IDENTIFYING OPERATION

The MA-1300 adopts the following clerk-identifying operations.

- Code Entry Type, using the [CLERK No.] key (standard)
- Clerk Lock Type, using the clerk keys (option)

Registering operations cannot be executed without clerk-identifying operation.

### 4-2-1 CODE ENTRY TYPE

**OPERATION** (must be operated outside a sale)

[Clerk No.] → [CLERK No.] ..... Sales entries are possible.  
 0 to 4  
 of the clerk  
 who operates the register

**NOTE:** Error results when the [CLERK No.] key is depressed without indexing the clerk No., or after indexing the numerics except for 0 to 4. However, when 0 is indexed as the clerk No., ECR goes into the clerk "OFF" status. In this status, the following keys only are operable. Numeric keys ([00], [0] to [9]), [C], [CLERK No.], [RF], and [JF].

### 4-2-2 CLERK LOCK TYPE

#### Key-lock Type

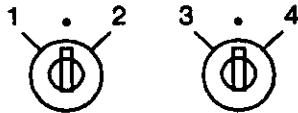

#### Clerk Keys (1, 2, 3, 4)

Each clerk should keep his/her clerk key. The register will not operate unless one of these keys is inserted and set to the correct position in the Clerk Locks. Each of the keys may be inserted and pulled out in the neutral position marked with the dot.

#### Push-key Type

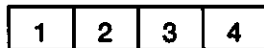

Each clerk is assigned his/her own clerk key (1 to 4). The register will not operate unless one of these keys is pushed down.



## 5. DISPLAY

The Operator's Display (front display) is located at the top of the register just above the keyboard. The Customer's Display may be used as Rear Display if it is kept in the receptacle or used as Remote Display if it is stretched up and turned to the required direction. The display has two types of display - - numeric display and message descriptors.

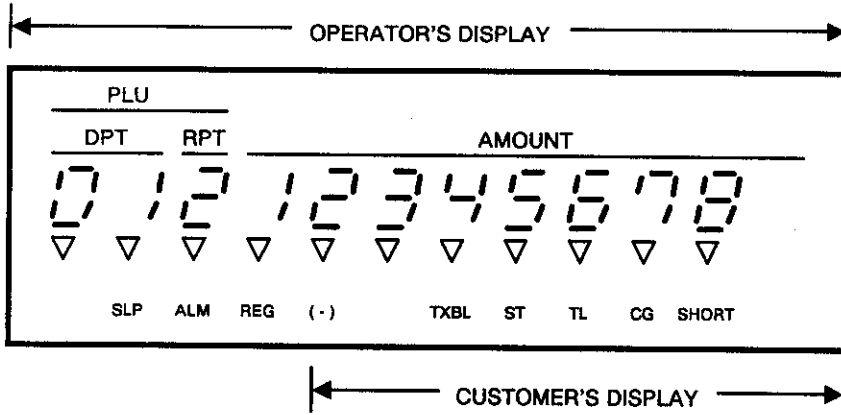

### NUMERIC DISPLAY

- AMOUNT (8 digits) :** Displays the numeric data, such as amount, quantity, etc.
- DPT (2 digits) :** Displays the code which represents each Department key. It stays lit when repeating the same department entry.
- RPT (1 digit) :** Displays the repeat count of the same item. The count is indicated from the second entry on, and only the last digit will be displayed even if the count exceeds nine.
- PLU (3 digits; the DPT and RPT digits are used for this purpose.):**  
Displays the PLU code when any PLU is entered. It goes out when repeating the same PLU entry.

**MESSAGE DESCRIPTORS (TRIANGULAR INDICATORS)**

- SLP :** Lights up when a slip has been properly inserted to allow validation.  
It flickers to require a validation when validation compulsory status has been programmed on the last operation.
- ALM :** Lights up with the alarm buzzer to indicate that the last operation or numeric entry was an error. To clear the error condition, depress the **[C]** key.
- REG :** Lights up when a sale item has been entered.
- ( - ) :** Lights up when the **[RTN MDSE]**, **[DOLL DISC]**, **[% - ]**, or **[ITEM CORR]** key has been operated. It also lights up when the **[ST]**, or one of the total keys has been depressed and the displayed amount is negative.  
It lights up also when an amount is entered in the "☐" mode.
- TXBL :** The "TXBL" descriptor lights up when a taxable item has been entered. Both
- ST :** "TXBL" and "ST" light up when the **[ST]** key is depressed, indicating that the amount displayed is the sale total including tax due.
- TL :** Lights up on a finalizing operation with the total amount displayed when a sale is finalized without any amount tendered.
- CG :** When an amount tendering operation has been performed, this lamp lights up with the change due displayed.
- SHORT :** Lights up when the amount tendered is less than the sale total with the shortage amount displayed.

## 6. KEYBOARD LAYOUT

The following is a typical keyboard layout for the MA-1300 series. Since this series is designed to be capable of programming most of the keys on the keyboard, this is merely an example. The keyboard of your register should have its own layout according to the store's requirements.

--- Standard Keyboard Layout (US Version) ---

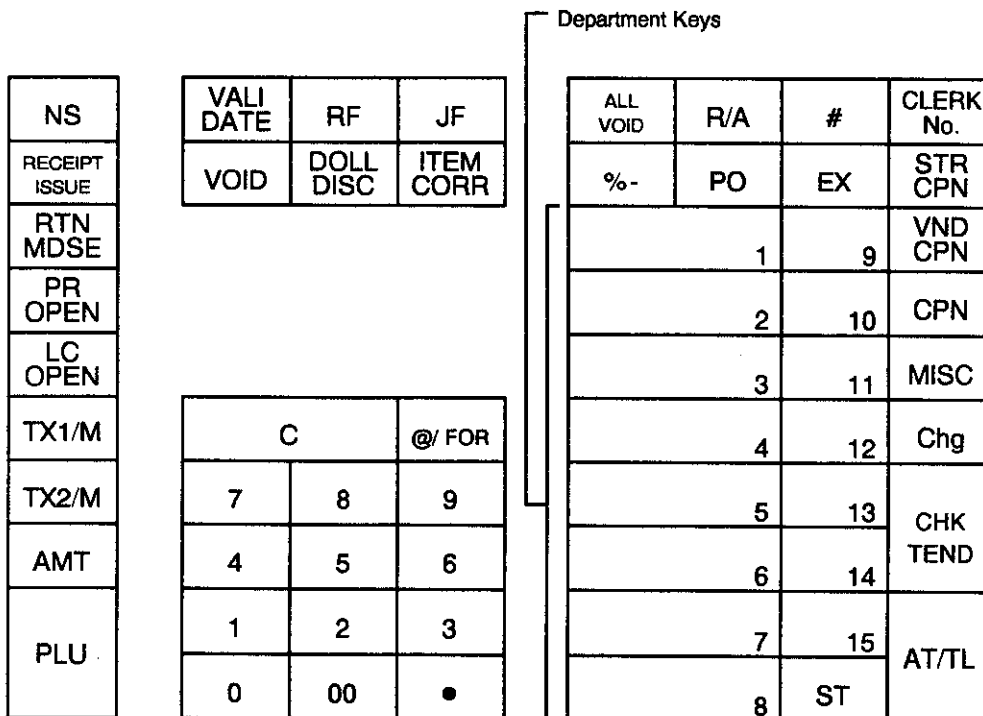

Other keys not placed in the keyboard above :

Additional Department Keys (16 to 30)

- [#/CID]
- [#/NS]
- [CUR 1] to [CUR 4]
- [% +]

--- Standard Keyboard Layout (CA Version) ---

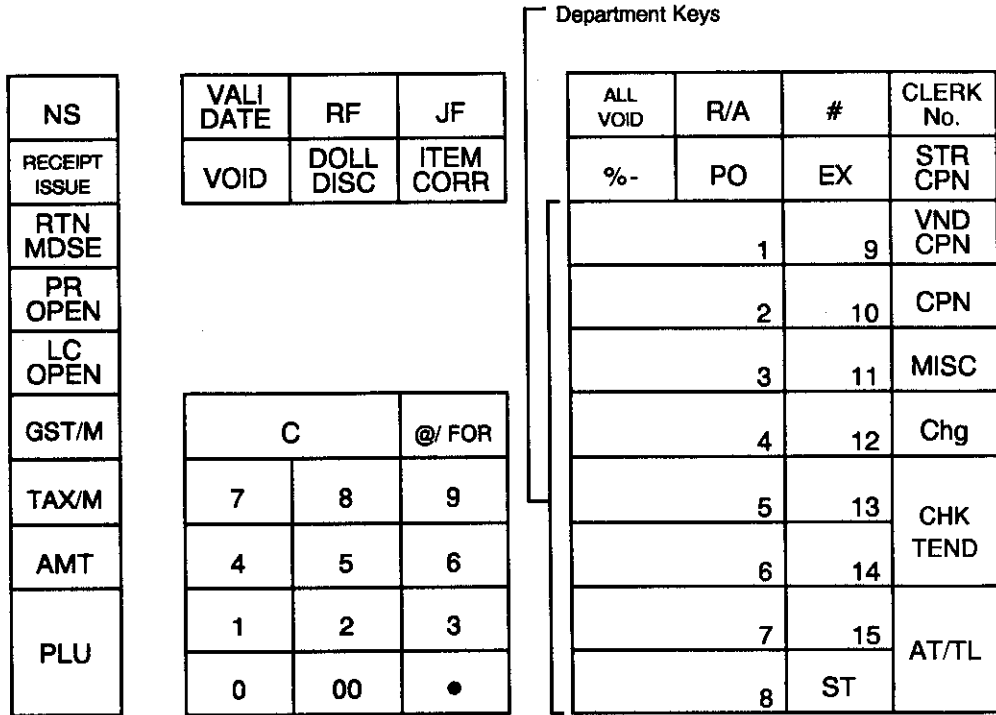

Other keys not placed in the keyboard above :

Additional Department Keys (16 to 30)

- [#/CID]
- [#/NS]
- [TX2/M]
- [CUR 1] to [CUR 4]
- [% +]

## 7. FUNCTION OF EACH KEY

On the following pages are brief descriptions of the function of each key. Actual operating procedures and print samples are introduced in the next chapter.

### TABLE OF CONTENTS

	Page		Page
[RECEIPT ON/OFF] .....	10	[ITEM CORR] .....	15
[RECEIPT ISSUE] .....	10	[VOID] .....	16
[RF] .....	10	[R/A] .....	16
[JF] .....	10	[PO] .....	16
NUMERIC KEYS .....	10	[ST] .....	17
[.] .....	11	[AT/TL] .....	17
[NS] .....	11	[CHK TEND] .....	18
DEPARTMENT KEYS .....	11	[Chg] .....	18
[PLU] .....	12	[MISC] .....	18
[C] .....	12	[CPN] .....	19
[#], [# /CID] .....	13	[VALIDATE] .....	19
[# /NS] .....	13	[TX1/M] [TX2/M] .....	19
[AMT] .....	13	[EX] .....	19
[PR OPEN] .....	13	[CUR1] to [CUR4] .....	20
[LC OPEN] .....	14	[ALL VOID] .....	20
[@ /FOR] .....	14	[VND CPN] .....	20
[RTN MDSE] .....	14	[STR CPN] .....	21
[DOLL DISC] .....	14	[CLERK No.] .....	21
[% +] .....	15	[GST/M] .....	21
[% -] .....	15		

**RECEIPT****RECEIPT ON/OFF SWITCH ([RECEIPT ON/OFF])**

This switch has two positions available: the 'OFF' position and 'ON' position. When in the 'OFF' position, no receipt is issued from the register and sales are printed on the journal roll only. When the switch is set to the 'ON' position, sales are printed on both receipt roll and journal roll, then a receipt is issued which is given to the customer.

**RECEIPT  
ISSUE**

**RECEIPT POST-ISSUE KEY ([RECEIPT ISSUE])**

This key is used to issue the receipt of a sale when the sale has already been finalized with the [RECEIPT ON/OFF] switch positioned to OFF.

This key will not function if another sale is already under way.

Post-issue receipt is itemized receipt for a sale of maximum 30 lines. Exceeding 30 lines, the post-issue receipt is total-only receipt.

**RF**

**RECEIPT FEED KEY ([RF])**

This key is used to advance the receipt roll. It is operated by depressing the key and holding it in that position until the paper has advanced to the required position. This key is effective even when the [RECEIPT ON/OFF] switch is in the 'OFF' position.

**JF**

**JOURNAL FEED KEY ([JF])**

This key is used to advance the journal roll in the same fashion as the [RF] key. These keys are useful if the operator, due perhaps to an interruption while ringing up a sale, is unsure which items have already been entered. By using the feed key the operator can see which figures have actually been printed.

The [RF] and [JF] keys cannot be operated simultaneously.

7	8	9
4	5	6
1	2	3
0	00	

**NUMERIC KEYS ( | \_\_\_\_\_ | )**

These keys are used to enter numeric values such as amount, quantity, or code number.

The maximum numeric entry digits vary according to each item or operation. Depressing the [00] key once is the same as depressing the [0] key twice consecutively.



## DECIMAL POINT KEY ([ . ])

This key used, as part of the numeric keys, to designate the decimal point position when entering a percent rate (through [% + ] or [%- ] ) or a quantity (through [ @/FOR ] ). For example, to enter 0.5%, index 0 → [ . ] → 5, or [ . ] → 5.

A maximum of three digits may be entered after the decimal point.

When entering a price or amount such as \$0.25 just index 2 → 5. In this case, depression of the [ . ] key is not necessary and will cause an error.



## NO SALE KEY ([NS])

This key is used to open the cash drawer while the machine is outside a sale. To operate, depress this key once. This function is usually used to break a big bill, or to check the receipt and journal print condition.

A non-add number may usually not be entered prior to a no-sale operation within one receipt sequence. However, it can be programmed to allow a no-sale operation after a non-add number entry.



}



## DEPARTMENT KEYS ([DEPT])

These are department keys through which sales items are registered. A maximum of 30 keys may be installed. Each of these keys may be programmed as either an 'OPEN' or 'PRESET' key.

### (1) OPEN DEPARTMENT KEY ([Open DEPT])

A department key which has no preset price programmed is an 'OPEN' key and it is necessary to enter a price manually each time. The price is rung up on the numeric keyboard and the appropriate department key is depressed. The price is then displayed and printed on the receipt and journal roll.

When the same department key is depressed more than once consecutively after a price entry, the price entry is repeated as many times as the department key is depressed.

### (2) PRESET DEPARTMENT KEY ([Preset DEPT])

A preset key is a key which already has a price programmed in it. It is therefore unnecessary to enter the price of an item; simply depress the key to register the sale of one item.

If a price different from the preset one must be entered through numeric keys into a preset department, depress the [PR OPEN] key before the price entry, followed by the department key.

## Single-item Departments

If a department is programmed as Single-item, the department entry sequence will immediately finalize the sale as cash sale without operating any of the media keys when operated outside a sale (i.e. when no other items have been entered within one receipt sequence). The Single-item Department will function, however, just as an ordinary itemized department if operated inside a sale.

PLU

### PLU (Price-Look-Up) KEY ([PLU])

A "PLU" is an individual merchandise item programmed with its own item code (PLU Code) and its link department. Each PLU can be programmed to a "Preset PLU" (to auto-enter the preset price) or an "Open PLU" (to enforce a price entry through the numeric keys each time)

#### To enter a Preset PLU:

| PLU Code | → [PLU] ... The preset price will automatically be read and entered.

Max. 3 digits (1 to 999)

To repeat the same PLU price, depress the [PLU] key only, after the above operation.

#### To enter an Open PLU:

| PLU Code | → [PLU] → | Price | → [AMT]

The price indexed through the numeric keys will be entered. To repeat the same PLU price, depress the [AMT] key only, after the above operation.

C

### CLEAR KEY ([C])

This key is used to clear a numeric entry or a declaration key (such as [RTN MDSE] ) entry if prior to depressing a motorized key (a key to execute printing of the entry, such as [DEPT] or media keys), or to correct any error condition and cancel the alarm.

When the [C] key is depressed after obtaining a sale total including taxes by the [ST] key, the same amount is displayed again.



#

**NON-ADD NUMBER PRINT ([#]),  
NON-ADD NUMBER PRINT/ CASH IN DRAWER KEY  
([#/CID])**

#/CID

This key is used to print a non-add number (such as Check No., Credit Card No., etc.) on the receipt and journal for future reference.

To operate, enter a maximum 8-digit number (the preceding zeros will not be printed if any entered), and then depress [#]. The number is then printed. This operation may be performed any time between sale items, before or after all the sale items if the sale has not yet been finalized. The numbers thus printed will not affect the sale total.

#/NS

**NON-ADD NUMBER PRINT/ NO-SALE KEY ([#/NS])**

This is a dual-function key that has both [#] and [NS] key functions. If depressed with a prior numeric entry, it will function as the Non-add Number Print Key.

If depressed without a prior numeric entry when the register is outside a sale, it will function as No-sale key.

AMT

**AMOUNT KEY ([AMT])**

This key is used to enter an amount or price for an open PLU. Refer to the description of the [PLU] key (page 12).

PR  
OPEN

**PRESET OPEN KEY ([PR OPEN])**

This key is used to modify the status of a preset department. When the [PR OPEN] key is depressed prior to operating a preset department, the preset department is reversed to an open department and this allows an amount entry through the numeric keys for that item only.

This key is also used to reverse a preset PLU to an open PLU.

**LC  
OPEN**

## **LISTING CAPACITY OPEN KEY ([LC OPEN])**

This key is used to release the listing capacity preprogrammed on each department (or on each open PLU linked to the department accordingly). To operate, depress [LC OPEN] before operating the department (or the PLU).

By depressing the [LC OPEN] key, the HALC (High Amount Listing Capacity) of the department or PLU will be released to allow a numeric entry with two more digits.

In order to allow an amount entry exceeding the value defined above, a Manager Intervention is necessary.

**@/FOR**

## **AT-FOR (QUANTITY EXTENSION AND SPLIT-PACKAGE PRICING) KEY ([@/FOR])**

This key is used to multiply a department or PLU item entry by a quantity (Multiplication Function). This key is also used to auto-calculate and enter a split-package price (in such a case as a customer wants only two of five tomatoes in one package; Split Price Function).

The order of multiplication is:

| QUANTITY | → [ @/FOR ] → | UNIT PRICE |

As for details of multiplication and split pricing for various cases, refer to the next chapter.

**RTN  
MDSE**

## **RETURNED MERCHANDISE KEY ([RTN MDSE])**

This key is used to refund money to a customer who has returned items already purchased.

To operate, depress this key before ringing up the amount to be refunded, and then operate the appropriate department (the department operation sequence may be replaced by a PLU entry sequence). The amount is automatically printed and deducted from the bill.

The [RTN MDSE] key can usually be used outside as well as inside a sale.

**DOLL  
DISC**

## **DOLLAR DISCOUNT KEY ([DOLL DISC])**

This key is used to subtract an amount from the sale such as a discount during a sale. An amount exceeding the sale total cannot be entered unless the "Credit Balance" option is selected.

To operate, enter the discount amount and then depress the [DOLL DISC] key. It may be operated after a [ST] key depression (Discount from Sale) or after individual Department or PLU item entry (Discount from Department).

## PERCENT CHARGE KEY ([% + ])

This key is used to add a percent rate to a sale. If the preset percent rate is to be added, depress the [% + ] key without a prior numeric entry. If a rate different from the preset one is to be added, enter the desired rate on the numeric keyboard and then depress the [% + ] key. The manual rate will then be added.

Use the [% + ] key after a department, or PLU if only that item requires the percent addition, or after the [ST] key if required on the total bill. The percentage rate and the amount are printed and will be added to the sale total.

The percent rate may be within the range from 0.001 to 99.999%.

Usually a % key operation after the [ST] key, is allowed only once. However, it may be programmed to be allowed more than once.

## PERCENT DISCOUNT KEY ([%-])

This key operates in the same fashion as the [% + ] key except that operation will subtract from instead of adding to a sale.

## ITEM CORRECT KEY ([ITEM CORR])

This key is used to remove the last item from a bill, printing a line through the item on the receipt and journal.

To operate, simply depress the [ITEM CORR] key immediately after the wrong item is entered and printed.

The item-correct function is effective even when a [C] key depression to clear a numeric entry is inserted between the line to be corrected and the [ITEM CORR] key depression. But when the [C] key is operated to cancel an error, the item-correct is no longer effective to delete the last item.

The [ITEM CORR] key will function to correct any last item entered through a Department, PLU, [% + ], [%-], [DOLL DISC], [R/A], or [PO].

VOID

**VOID KEY ([VOID])**

The **[VOID]** key is used to delete an item entered previously (before the last line item) within a sale, in which case the **[ITEM CORR]** key will not function.

To operate, depress the **[VOID]** key before a normal department or PLU entry sequence.

The **[VOID]** key will function to delete a previous item through a department or a PLU, or a combination of department PLU plus % +/%- entry, but not any other kind of items.

The **[VOID]** key cannot be used along with **[RTN MDSE]** key. But quantity extension (multiplication) and split package pricing possible with the **[VOID]** key.

To delete a purchased item a sale already finalize, the **[RTN MDSE]** key will be used instead of the **[VOID]** key. Thus the **[VOID]** key must be operated inside sale, and the amount entered through **[VOID]** must no exceed the sale total. However, when the option "Over- subtraction using **[VOID]** Allowed" is selected, over-subtraction of the sale is allowed and accordingly **[VOID]** may be used outside a sale as well.

R/A

**RECEIVED-ON-ACCOUNT KEY ([R/A])**

A received-on-account transaction is used to identify money which is in the drawer but not due to business. The amount entered is thus included in the in-drawer Total memories but not in the sales total memories.

To operate, enter an amount of payment and then depress the **[R/A]** key. Repeat this operation if multiple payments are recorded within one receipt. The payments entered are finalized by the **[AT/TL]** key if paid in cash. Other media keys also finalize such payments if so programmed. The above operation sequence can only be performed when the register is outside a sale.

PO

**PAID-OUT KEY ([PO])**

A paid-out transaction is used when an amount of money is removed from the cash drawer without relating to a sale, for the purpose of paying wholesalers, etc. When the **[PO]** key is used, the amount entered is subtracted from the Cash-in-drawer Total memory but not sales totals.

To operate, enter an amount to be taken from the cash drawer and depress the **[PO]** key while the register is in an out-of-sale condition. This operation may be repeated if multiple paid-out items are registered in one transaction. The paid-out amounts are finalized by the **[AT/TL]** key only (i.e., must always be paid out in cash).

ST

**SUBTOTAL KEY ([ST])**

This key is used to obtain the subtotal amount including tax due during a sale. When this key is depressed after all the items have been rung up, a subtotal amount including tax due is displayed, and the amount excluding tax due is printed.

Mandatory depression of this key prior to finalizing a sale is a program option.

AT/TL

**CASH AMOUNT TENDERED / CASH TOTAL KEY ([AT/TL])**

-- Cash Media Key

This key is used to record all cash paid on transactions, and will be able to finalize a sale operation. Usually this key is programmed to function as both "Tender" and "Total" key. However, the key may be programmed to operate only with enforced tendering or only as a cash total key.

**TENDER FUNCTION**

After the [ST] key is depressed, enter the amount tendered by the customer in payment of the sale, and then depress the [AT/TL] key. The change is automatically computed, displayed, and printed.

If the amount tendered is smaller than the sale total, it prints the amount tendered on the receipt with the balance due displayed, but the drawer is not yet opened. In this case, ask the customer for additional payment in cash and repeat the same amount-tendering operation, or use another media key if the balance due is processed as a sale in that media.

**NOTE:** *Even if [AT/TL] is programmed to function as Tender-only key and the sale total is zero or negative, no amount tendered can be entered. In this case, [AT/TL] will function just as the Total key, so just depress [AT/TL] to obtain the total and finalize the sale. The balance in negative indicates that the amount must be paid back to the customer in cash.*

**TOTAL FUNCTION**

To obtain the total and finalize a cash sale, depress the [AT/TL] key only. The sale is finalized with the total printed and displayed, and the drawer opens.

If the "[ST] Compulsory" option is selected, a [ST] key depression is always required before finalizing a sale.

The [AT/TL] key is also used to finalize Received-on-Account payments or Paid-Out amounts.

**CHK  
TEND**

## **CHECK TENDER KEY ([CHK TEND])**

This is one of the non-cash media keys, and is used to cash a check when the register is outside a sale, or to finalize the transaction as a check payment.

### CHECK CASHING WITH NO PURCHASE

When the register is outside a sale, enter the check amount and depress the **[CHK TEND]** key. A receipt is issued and the drawer is opened to enable exchange. However, this cashing function may be prohibited by a program selection.

### FINALIZING AS CHECK PAYMENT

For finalizing a sale with **[CHK TEND]**, refer to the **[AT/TL]** key description. The **[CHK TEND]** key is usually programmed to function as a Tender-only key. However, it may be programmed to function as a Total-only key or as both Tender and Total key, just as **[AT/TL]**.

The **[CHK TEND]** key is also used to finalize Received-on-Account payments when paid in check, if programmed to allow it.

When the key is programmed to allow tendering, over-tendering using this key may also be programmed to be prohibited.

**Chg**

## **CHARGE KEY ([Chg])**

This is another non-cash media key, and is usually programmed as a "Charge Sale Total" key. However, it may be programmed to be a key for other media such as payments by credit card. To operate as a general charge sale finalizing key, depress **[Chg]**, instead of **[AT/TL]**, to obtain the total and finalize the sale.

This key has exactly the same functions and programmabilities as the **[CHK TEND]** key except that **[Chg]** is usually programmed as Total-only key but not Tender key.

**MISC**

## **MISCELLANEOUS MEDIA KEY ([MISC])**

This is one of the additional non-cash media keys that may be installed besides **[CHK TEND]** and **[Chg]**. This key has the same functions and programmabilities as the **[CHK TEND]** key, and is usually used as the Tender-only key.

CPN

**MEDIA-COUPON KEY ([CPN])**

This key is used to finalize a sale paid in coupons. This key has the same functions and programmabilities as the **[CHK TEND]** key and is usually used as the Tender only key.

VALI  
DATE**VALIDATION KEY ([VALIDATE])**

This key is used to print a validation slip.

To operate, after registering a required item or finalizing a required sale, insert the slip into the validation slot and depress the **[VALIDATE]** key. The item and the amount will be printed in one line on the slip. Print or non-print of the consecutive No. or clerk No. is program option.

Program selection are also provided for single- or multi-validation (number of times validation allowed for the same item), validation compulsion on certain transaction keys.

TX1/M

**TAX MODIFIER KEYS ([TX1/M], [TX2/M])**

TX2/M

These keys are used to reverse the Tax status (taxable/non-taxable status) on departments, PLUs, or other tax-status-programmable keys (**[DOLL DISC]**, **[VND CPN]**, **[STR CPN]**, **[% + ]**, and **[%- ]**) for one entry only. On the CA model, this modifier key is applied for PST tax.

To operate, depress the required tax modifier keys prior to depressing any of those function keys listed above.

The tax modifier keys are also used, along with the **[EX]** key, to exempt required tax(es) from the sale. Refer to the **[EX]** key description for this purpose.

EX

**TAX EXEMPT KEY ([EX])**

This key is used to declare the exemption of the taxes from the sale, displaying the sale total excluding the exempted tax(es), printing the pre-taxed amount of the sale portion subject to the tax exemption. Only a finalizing operation is possible after the **[EX]** key is operated.

When dual tax modifier keys are installed, partial tax exemption as well as total tax exemption may be performed.

CUR  
1

to

CUR  
4**FOREIGN CURRENCY KEYS ([CUR]; [CUR 1] to [CUR 4])**

These keys are used in tendering with foreign currencies. Each of these corresponds to a foreign currency and is programmed with a preset exchange rate.

**PAYMENT OF A SALE IN A FOREIGN CURRENCY**

For finalizing the sale, depress the **[ST]** key. (The **[ST]** key is always mandatory for this operation.) The total (including taxes) is displayed in the domestic currency value. Next, depress the **[CUR]** key corresponding to the required foreign currency, and the sale total is displayed in that currency value exchanged from the domestic currency value. Then an amount tendered in that foreign currency may be entered (displaying the amount in the foreign currency) and the same **[CUR]** key will be depressed (now displaying the domestic currency amount exchanged from the entered foreign currency amount). Finally, depress the media key according to the media paid (usually **[AT/TL]** for cash payment). The change due is displayed and printed in the domestic currency value. If the tendered amount is short, the balance due is displayed in the domestic currency value, and multi-tendering with the same **[CUR]** key may continue.

**NO-SALE EXCHANGE FROM A FOREIGN CURRENCY TO THE DOMESTIC CURRENCY**

When the register is outside a sale, depress the **[CUR]** key. The display zero format will be that of the designated currency. Next, enter the foreign currency amount and then depress the **[NS]** key. The domestic currency amount equivalent to the entered foreign currency amount is displayed and printed, the drawer opens, and a receipt is issued.

ALL  
VOID**ALL VOID KEY ([ALL VOID])**

The **[ALL VOID]** key is used to delete all items entered in the current transaction.

To operate, depress the **[ALL VOID]** key, followed by the **[ITEM CORR]** key after registering items.

VND  
CPN**VENDOR COUPON KEY ([VND CPN])**

The **[VND CPN]** key is used to enter the amount of vendor coupons received from the customer.

To operate, enter an amount of vendor coupon, then depress the **[VND CPN]** key.



**STR  
CPN****STORE COUPON KEY ([STR CPN])**

The **[STR CPN]** key is used to subtract a store coupon amount redeemed through a department.

To operate, depress this key, then enter a department item.

**CLERK  
No.****CLERK No. KEY ([CLERK No.])**

The **[CLERK No.]** key is used to identify which clerk is operating the register. Refer to page 4.

**GST/M****GST TAX MODIFIER KEY ([GST/M])**

The **[GST/M]** key is provided to the CA model only. This key operates the same to reverse from the GST taxable status to non-taxable, and vice versa, of the required item.

## 8. REGISTERING PROCEDURE AND RECEIPT SAMPLES

The following pages are registering operation patterns and actual operation samples. In the patterns, " | \_\_\_\_\_ | " indicates an input through the numeric keys, "[ ]" indicates a depression of the transaction key, and " --- " indicates other registering and /or finalizing operations. In referring to the sample operations, please note that the programmed data on some keys or items (such as Department keys) may be different from those programmed for your store.

### CONDITION SETTING TO START REGISTERING

Mode Lock : Insert the "REG" key and set it to the "REG" position.

Clerk Identifying Operation: You must operate the code entry, or set your clerk key to the ON status.

### TABLE OF CONTENTS

	Page
NO-SALE .....	23
RECEIVED-ON-ACCOUNT .....	24
PAID-OUT .....	25
DEPARTMENT ENTRY .....	26
PLU ENTRY .....	28
REPEAT ENTRY .....	29
QUANTITY EXTENSION (MULTIPLICATION) .....	30
SPLIT PACKAGE PRICING .....	32
RETURNED MERCHANDISE .....	33
PERCENT DISCOUNT .....	34
DOLLAR DISCOUNT .....	35
VOID .....	36
ITEM CORRECT .....	37
NON-ADD NUMBER PRINT .....	38
LISTING CAPACITY OPEN .....	38
TAX STATUS/GST TAX STATUS MODIFICATION .....	38
SUBTOTAL READ .....	39
TAX EXEMPT .....	40
SALES FINALIZATION BY MEDIA KEYS .....	41
MULTI-TENDER .....	42
SPLIT-TENDER .....	43
CHECK CASHING .....	45
SALE PAID IN FOREIGN CURRENCIES .....	46
NO-SALE EXCHANGE FROM A FOREIGN CURRENCY TO THE DOMESTIC CURRENCY .....	47
RECEIPT POST-ISSUE .....	48
VALIDATION PRINT .....	49
OTHER INCOME ENTRY .....	50
ALL VOID (CANCEL) .....	51
VENDOR COUPON .....	52
STORE COUPON .....	53
ENTRY IN "E" MODE .....	54

**NO-SALE** (must be operated outside a sale)

[NS]

SAMPLE OPERATION CONTENTS	KEY OPERATION	DISPLAY										
		PLU		AMOUNT								
		GPT	RPT	DL	AL	RE	(-)	TZ	ST	TL	CG	SH
<p>You want to test the printer condition before starting operations for the day.</p> <p>Or a customer requests to break a bill.</p>	<p>[NS]</p> <p>The drawer opens.</p>									0	0	0

**TEC STORE**  
 1343 PEACH DRIVE  
 PHONE: 87-6437  
  
 Thank you      Call again  
  
 11-20-91 #3001  
  
 •NO SALE•  
  
 JONES      0003 10:23

# RECEIVED-ON-ACCOUNT (must be operated outside a sale)

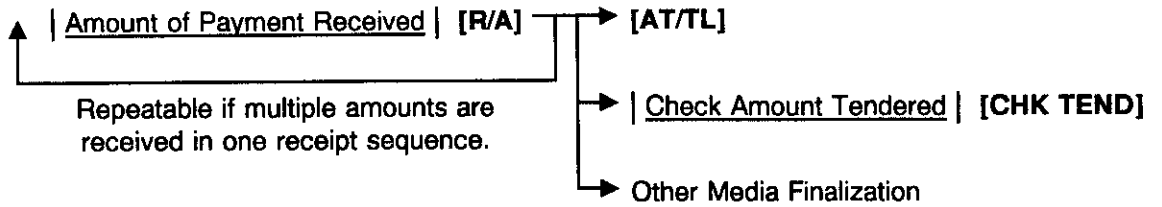

**NOTE :** The media keys used for this operation must be programmed to allow received-on-account entries.

SAMPLE OPERATION CONTENTS	KEY OPERATION	DISPLAY									
		PLU		AMOUNT							
		OPT	RPT	BL	AL	RE (-)	TX	BT	TL	CG	SH
A customer comes and settles his account for a sale made on a different day (finalized as a charge sale), not related to today's sale business. The Customer's Account No. is 15. • Paid Amount \$10.00 • Paid Amount \$2.50 The customer tenders the exact a amount in cash. Receive \$12.50 and put it in the drawer.	15							0	1	5	
	[#]							0	1	5	
	1000							1	0	0	0
	[R/A]							1	0	0	0
	250								2	5	0
	[R/A]								2	5	0
	[AT/TL]							1	2	5	0

```

    TEC STORE
    1343 PEACH DRIVE
    PHONE: 87-6437

    Thank you      Call again

    11-20-91 #3001

    #15
    R/A           $10.00
    R/A           $2.50
    CASH         $ 1 2 . 5 0

    JONES        0004 10:24
  
```

**PAID-OUT** (must be operated outside a sale)

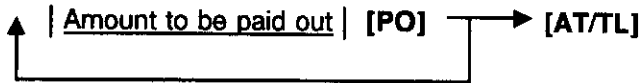

Repeatable if multiple amounts to be paid out are recorded in one receipt sequence.

**NOTE :** Only [AT/TL] can finalize paid-out amounts. (i.e. must always be paid out in cash.)

SAMPLE OPERATION CONTENTS	KEY OPERATION	DISPLAY										
		PLU		AMOUNT								
		DPT	RPT	SL	AL	RE	(-)	TX	ST	TL	CO	SH
You must pay for merchandise the store has purchased.  You assign Code No. 2003 to this wholesaler for future reference. • \$4.50 • \$3.20  Pay the total amount \$7.70 to the wholesaler out of the drawer.	2003								2	0	0	3
	[#]								2	0	0	3
	450									4	5	0
	[PO]									4	5	0
	320									3	2	0
	[PO]									3	2	0
	[AT/TL]								7	7	0	
									▼			

**T E C S T O R E**  
 1343 PEACH DRIVE  
 PHONE: 87-6437

Thank you      Call again

11-20-91 #3001

#2003  
 PO                \$4.50  
 PO                \$3.20  
 TOTAL            \$ 7 . 7 0

JONES            0005 10:24



## DEPARTMENT ENTRY

**Open Department (Itemized Dept)**  
 (--- → ) | Price | [Open DEPT] → ---

**Preset Department (Itemized Dept)**  
 (--- → ) [Preset DEPT] → ---  
 (--- → ) | Price | [Preset DEPT] → ---  
 ↑ or ↑ [PR OPEN]

### Single-item Department

Operates the same as Itemized Departments, except that the sale is finalized as cash in case a Single-item Department is entered when operated outside a sale.

SAMPLE OPERATION CONTENTS	KEY OPERATION	DISPLAY										
		PLU		AMOUNT								
		DEPT	RPT	SI	AL	RE	(.)	TX	ST	TL	CG	SH
<b>Open Dept (Itemized)</b> A Dept.1 item (coffee) of \$1.23 (Dept.1 is programmed as an Open, Itemized dept) (The sale is not finalized until a media key is operated.)	123									1	2	3
	[DEPT 1]	0	1			▼		▼		1	2	3
												
<b>Preset Dept (Itemized)</b> A Dept.2 item (cake) which is preset with a price of \$2.50. (The sale is not finalized until a media key is operated.)  A Dept.2 item of \$1.50. (which is preset with price of \$2.50.)	[DEPT 2]	0	2			▼		▼		2	5	0
	[PR OPEN]					▼				0	0	0
	150									1	5	0
	[DEPT 2]	0	2			▼		▼		1	5	0
												
<b>Single-Item Dept-</b> -- outside a sale --  A Dept.8 item of \$1.40 (Dept.8 is programmed as an Open, Single-item dept) (The sale is immediately finalized as cash.)	140									1	4	0
	[DEPT 8]	0	8							1	4	7

**T E C   S T O R E**  
1343 PEACH DRIVE  
PHONE: 87-6437

Thank you      Call again

11-20-91 #3001

D P 08	\$1.40 T
TAX	\$0.07
CASH	\$ 1 . 4 7

JONES      0008 12:10

# PLU ENTRY

## Preset PLU (Itemized PLU)

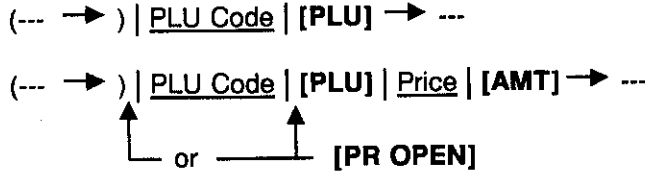



## Open PLU (Itemized PLU)



## Single-Item PLU

A PLU linked to a Single-item Department will automatically function as a Single-item PLU, and immediately finalizes the sale as cash on an entry when operated outside a sale.

SAMPLE OPERATION CONTENTS	KEY OPERATION	DISPLAY									
		PLU			AMOUNT						
		DPT	RPT		TX	ST	TL	CG	SH		
<b>Preset PLU (Itemized)</b> An item of PLU No.11 (preset price \$3.00) (The sale is not finalized until a media key is operated.)	11 [PLU] 	0	1	1					0	1	1
<b>Open PLU (Itemized)</b> To enter \$2.00 through PLU No. 500 (open-PLU).	500 [PLU] 200 [AMT] 	5	0	0					5	0	0
		5	0	0					2	0	0
		5	0	0					2	0	0



# REPEAT ENTRY

(1) Department Repeat

- Open Dept  
(--- → ) | Price | [Open DEPT] → [same DEPT] → ---
- Preset Dept  
(--- → ) | [Preset DEPT] → [same DEPT] → ---

(2) PLU Repeat

- Open PLU  
(--- → ) | PLU Code | [PLU] | Price | [AMT] → [AMT] → ---
- Preset PLU  
(--- → ) | PLU Code | [PLU] → [PLU] → ---

Depress the last key of the sequence as many times as the desired count.

SAMPLE OPERATION CONTENTS	KEY OPERATION	DISPLAY										
		PLU		AMOUNT								
		DPT	RPT	BL	AL	RE	( )	TX	ST	FL	CG	SH
To enter the following item within a sale:  3 items of Dept.1 (open dept), unit price \$1.20	120									1	2	0
	[DEPT 1]	0	1		▼		▼			1	2	0
	[DEPT 1]	0	1	2	▼		▼			1	2	0
	[DEPT 1]	0	1	3	▼		▼			1	2	0
	[DEPT 2]	0	2		▼		▼			2	5	0
	[DEPT 2]	0	2	2	▼		▼			2	5	0
<div style="border: 1px dashed black; padding: 5px; margin: 10px 0;">                     COFFEE      \$1.20 T                      COFFEE      \$1.20 T                      COFFEE      \$1.20 T                      CAKE         \$2.50 T                      CAKE         \$2.50 T                 </div>												

## QUANTITY EXTENSION (MULTIPLICATION)

### (1) Department Multiplication

- Preset Dept

(--- → ) | Quantity | [@/FOR] [Preset DEPT] → ---

└─ may be omitted if the Quantity is one digit

- Open Dept

(--- → ) | Quantity | [@/FOR] | Price | [Open DEPT] → ---

- Preset Price Open

(--- → ) | Quantity | [@/FOR] | Price | [Preset DEPT] → ---

↑            ↑            ↑            ↑  
 ─────────────────────────────────── [PR OPEN]  
 anywhere of these timings

### (2) PLU Multiplication

- Preset PLU

(--- → ) | Quantity | [@/FOR] | PLU Code | [PLU] → ---

- Open PLU

(--- → ) | PLU Code | [PLU] | Quantity | [@/FOR] | Price | [AMT] → ---

- Preset Price Open

(--- → ) | PLU Code | [PLU] | Quantity | [@/FOR] | Price | [AMT] → ---

↑            ↑  
 ─── or ─── [PR OPEN]

SAMPLE OPERATION CONTENTS	KEY OPERATION	DISPLAY								
		PLU			AMOUNT					
		DPT	RPT		TX	ST	TL	OO	SP	
To enter the following items:  5 items of PLU No.11 (preset PLU), preset price \$3.00.  6 items of PLU No.500 (open PLU), unit price \$2.00.	5							0	0	5
	[@/FOR]							0	0	5
	11							0	1	1
	[PLU]	0	1	1	▼	▼	1	5	0	0
	500							5	0	0
	[PLU]	5	0	0	▼			0	0	0
	6							0	0	6
	▼									
	▼									
	▼									
200							2	0	0	
[AMT]	5	0	0	▼	▼	1	2	0	0	

5X	3.000
PLU011	\$15.00 T
6X	2.000
PLU500	\$12.00 T

# SPLIT PACKAGE PRICING

This operation is applied for Department items only.

· Preset Dept

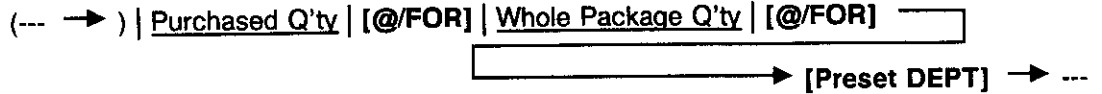

· Open Dept

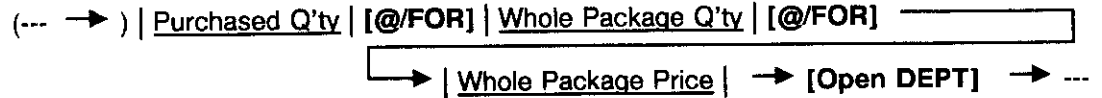

**NOTES :** 1. Purchased Quantity ..... max. 3 digits integral only  
 Whole Package Quantity ..... max. 3 digits integral only  
 Whole Package Price ..... max. 6 digits integral only

2. The fraction of the result is always rounded up in split price operations.

SAMPLE OPERATION CONTENTS	KEY OPERATION	DISPLAY																			
		PLU		AMOUNT																	
		DPT	RPT	SL	AL	RE	(1-)	TX	ST	TL	CO	SH									
To enter :  3 items out of 5 items in a package of Dept.5 (fruit) (preset dept.)	3																				
	[ @/FOR ]																				
	5																				
	[ @/FOR ]																				
	[ DEPT 5 ]	0	5																		
	3X 3.50/ 5 FRUIT \$2.10 T																				

# RETURNED MERCHANDISE or DESIGNATED LINE VOID

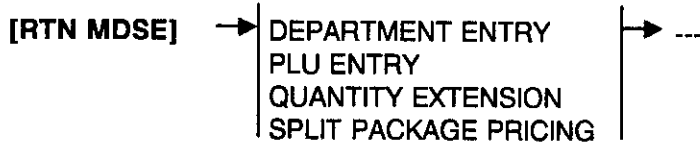

SAMPLE OPERATION CONTENTS	KEY OPERATION	DISPLAY										
		PLU		AMOUNT								
		DPT	RPT	TX	ST	TL	CO	SH				
<b>Return Entry Outside a Sale</b>  A customer comes up to return a \$5.00 item of Dept.1. No other sale items at this time.  The sale total is now negative, therefore the total amount displayed must be paid back to the customer in cash.	[RTN MDSE]									0	0	0
	500									5	0	0
	[DEPT 1]	0	1							5	0	0
	[AT/TL]									5	5	0

**TEC STORE**  
 1343 PEACH DRIVE  
 PHONE: 87-6437  
  
 Thank you      Call again  
  
 11-20-91 #3001  
  
 RTN                      \$5.00-T  
 COFFEE                \$0.50-  
 TAX                      \$ 5 . 5 0-  
 CASH  
  
 JONES                0019 12:29

# PERCENT DISCOUNT

(PERCENT CHARGE operates the same with [% + ] instead of [%-])

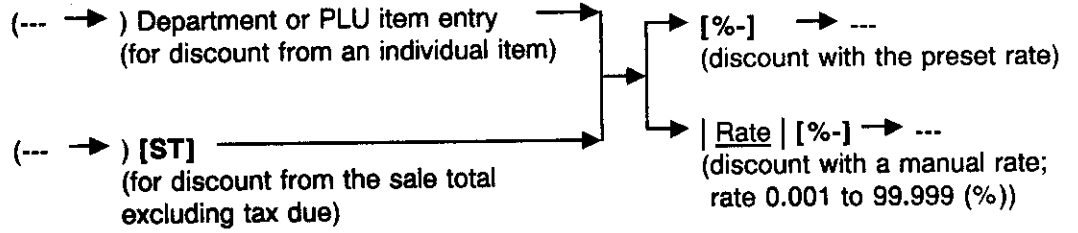

SAMPLE OPERATION CONTENTS	KEY OPERATION	DISPLAY										
		PLU		AMOUNT								
		DFT	RPT	SL	AL	RE	TX	ST	TL	CG	SH	
<b>Percent Discount from a Department Item</b> A Dept.1 item of \$2.00 is entered. 5% is discounted from the above item.	200										2.00	00
	[DEPT 1]	0	1								2.00	00
	[%-] (if 5% is preset)										0.10	00
	COFFEE \$2.00 T %- 5% \$0.10-											
<b>Percent Discount from a Sale Total</b> 10% is subtracted from entire sale total.	Sale items have been entered											
	[ST]										4.71	
	10 (Manual % Rate)										0.10	00
	[%-]										0.43	00
	SUBTL \$4.25 %- 10% \$0.43-											

# DOLLAR DISCOUNT

(--- → ) | Amount to be discounted | [DOLL DISC] → ---

(An amount exceeding the subtotal cannot be entered through the [DOLL DISC] key unless the option "Credit Balance Allowed" is selected.)

SAMPLE OPERATION CONTENTS	KEY OPERATION	DISPLAY										
		PLV		AMOUNT								
		DPT	RPT	SL	AL	RE	(-)	TK	ST	TL	CG	SH
During a sale an amount of \$0.50 is discounted from the sale.	Sale items have been entered. 50 [DOLL DISC] 											
					▼					0.	5	0
					▼	▼				0.	5	0

# VOID

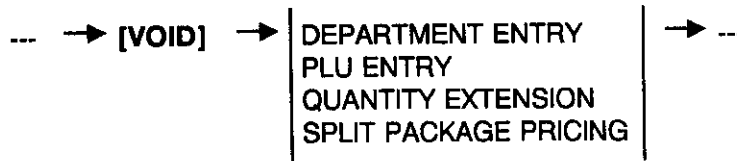

**NOTE :** The amount entered with the [VOID] key must not exceed the sale total amount unless the option "Credit Balance Allowed" is selected.

SAMPLE OPERATION CONTENTS	KEY OPERATION	DISPLAY											
		PLU		AMOUNT									
		DPT	RPT	ST	AL	RE	(-)	TX	ST	TL	CG	SH	
You enter the following items during a sale : • Dept. 1 \$1.00 • Dept. 2 \$1.50  Then you find that the first item (Dept 1) was wrong and must be deleted.	100									1	0	0	
	[DEPT 1]	0	1			▼			▼		1	0	0
	[PR OPEN]					▼					0	0	0
	150					▼					1	5	0
	[DEPT 2]	0	2			▼			▼		1	5	0
	[VOID]					▼					0	0	0
	100					▼					1	0	0
	[DEPT 1]	0	1			▼	▼		▼		1	0	0
<div style="border: 1px solid black; padding: 5px; margin-top: 10px;">                         COFFEE      \$1.00 T                          CAKE        \$1.50 T                          VOID                          COFFEE      \$1.00-T                     </div>													



# ITEM CORRECT (Last Line Voiding)

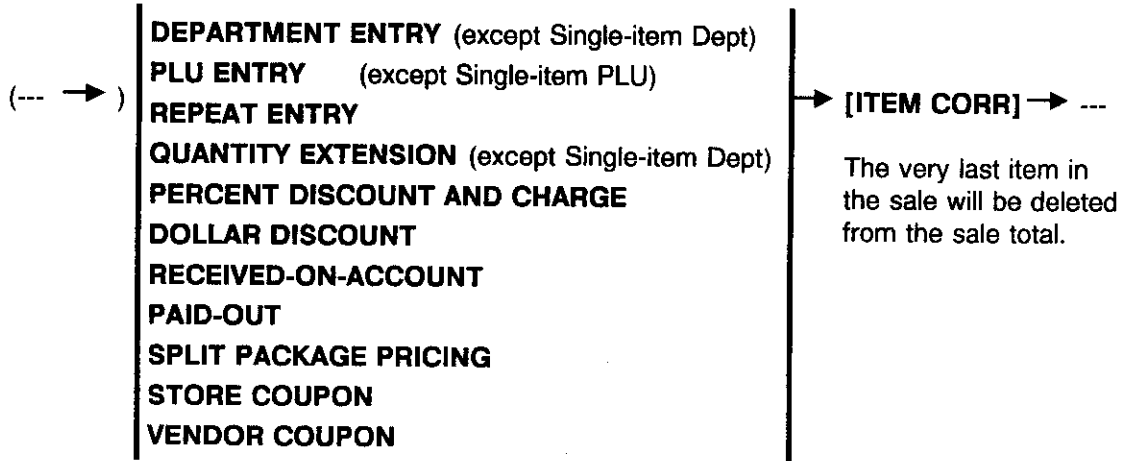

- NOTES :**
- 1) When [ITEM CORR] is operated after a REPEAT ENTRY, only the last item of the repeated entries is deleted.
  - 2) When [ITEM CORR] is operated after a QUANTITY EXTENSION, the entire product (the result of multiplication) is deleted.

SAMPLE OPERATION CONTENTS	KEY OPERATION	DISPLAY																																																																																										
		PLU		AMOUNT																																																																																								
		DPT	RPT	DL	AL	RE	(-)	TX	ST	TL	CO	SH																																																																																
A Dept.2 item (preset price \$2.50) is entered, but you immediately notice that the entry is wrong.	[DEPT 2]  [ITEM CORR]  <div style="border: 1px dashed black; padding: 5px; width: fit-content; margin: 10px auto;">                         EAKE-----\$2.50-T                     </div>	<table style="width: 100%; border-collapse: collapse;"> <tr> <td style="width: 5%;">0</td> <td style="width: 5%;">2</td> <td style="width: 5%;"></td> <td style="width: 5%;"></td> <td style="width: 5%;"></td> <td style="width: 5%;"></td> <td style="width: 5%;"></td> <td style="width: 5%;"></td> <td style="width: 5%;"></td> <td style="width: 5%;"></td> <td style="width: 5%;"></td> <td style="width: 5%;"></td> </tr> <tr> <td></td> <td></td> <td></td> <td style="text-align: center;">▼</td> <td></td> <td></td> <td></td> <td></td> <td style="text-align: center;">▼</td> <td></td> <td style="text-align: center;">2</td> <td style="text-align: center;">5</td> <td style="text-align: center;">0</td> </tr> <tr> <td>0</td> <td>2</td> <td>0</td> <td></td> <td style="text-align: center;">▼</td> <td style="text-align: center;">▼</td> <td></td> <td></td> <td style="text-align: center;">▼</td> <td></td> <td style="text-align: center;">2</td> <td style="text-align: center;">5</td> <td style="text-align: center;">0</td> </tr> </table>	0	2														▼					▼		2	5	0	0	2	0		▼	▼			▼		2	5	0																																																				
0	2																																																																																											
			▼					▼		2	5	0																																																																																
0	2	0		▼	▼			▼		2	5	0																																																																																
5 x Dept.1 item of unit price \$1.30 is entered, but you immediately notice that the entry is wrong.	5  [ @/FOR ]  130  [DEPT 1]  [ITEM CORR]  <div style="border: 1px dashed black; padding: 5px; width: fit-content; margin: 10px auto;">                         5X      1.300                          EOFFEE-----\$6.50-T                     </div>	<table style="width: 100%; border-collapse: collapse;"> <tr> <td style="width: 5%;"></td> <td style="width: 5%;"></td> <td style="width: 5%;"></td> <td style="width: 5%;"></td> <td style="width: 5%;"></td> <td style="width: 5%;"></td> <td style="width: 5%;"></td> <td style="width: 5%;"></td> <td style="width: 5%;"></td> <td style="width: 5%;"></td> <td style="width: 5%;"></td> <td style="width: 5%;"></td> </tr> <tr> <td></td> <td></td> <td></td> <td></td> <td></td> <td></td> <td></td> <td></td> <td></td> <td></td> <td style="text-align: center;">0</td> <td style="text-align: center;">0</td> <td style="text-align: center;">5</td> </tr> <tr> <td></td> <td></td> <td></td> <td></td> <td></td> <td></td> <td></td> <td></td> <td></td> <td></td> <td style="text-align: center;">0</td> <td style="text-align: center;">0</td> <td style="text-align: center;">5</td> </tr> <tr> <td></td> <td></td> <td></td> <td></td> <td></td> <td></td> <td></td> <td></td> <td></td> <td></td> <td style="text-align: center;">1</td> <td style="text-align: center;">3</td> <td style="text-align: center;">0</td> </tr> <tr> <td>0</td> <td>1</td> <td></td> <td></td> <td></td> <td></td> <td></td> <td></td> <td></td> <td></td> <td style="text-align: center;">6</td> <td style="text-align: center;">5</td> <td style="text-align: center;">0</td> </tr> <tr> <td>0</td> <td>1</td> <td>0</td> <td></td> <td style="text-align: center;">▼</td> <td></td> <td></td> <td></td> <td style="text-align: center;">▼</td> <td></td> <td style="text-align: center;">6</td> <td style="text-align: center;">5</td> <td style="text-align: center;">0</td> </tr> <tr> <td></td> <td></td> <td></td> <td></td> <td style="text-align: center;">▼</td> <td style="text-align: center;">▼</td> <td></td> <td></td> <td style="text-align: center;">▼</td> <td></td> <td></td> <td></td> <td></td> </tr> </table>																							0	0	5											0	0	5											1	3	0	0	1									6	5	0	0	1	0		▼				▼		6	5	0					▼	▼			▼				
										0	0	5																																																																																
										0	0	5																																																																																
										1	3	0																																																																																
0	1									6	5	0																																																																																
0	1	0		▼				▼		6	5	0																																																																																
				▼	▼			▼																																																																																				

## NON-ADD NUMBER PRINT

(--- → ) | Number to be printed as reference | [#] → ---  
 max. 8 digits; 1 to 99999999

Operation Samples in : RECEIVED-ON-ACCOUNT  
 PAID-OUT  
 CHARGE SALE TOTAL

## LISTING CAPACITY OPEN

Depress [**LC OPEN**] prior to or any time during an entry of a department or a PLU sequence (including REPEAT and QUANTITY EXTENSION entries). Please note that the [**LC OPEN**] key must be pressed, at the latest, before the final key of the entry sequence. The HALC (High Amount Listing Capacity) for the department or PLU will be extended with two higher digits. For entering an amount still exceeding these limits, you must call for a Manager Intervention.

## TAX STATUS MODIFICATION, GST TAX STATUS MODIFICATION

Depress [**TX/M**] (and/or [**TX1/M**], [**TX2/M**]) (PST tax modifier for CA version) in the same way as [**LC OPEN**] is operated, prior to or any time during the entry sequence of the required Department, PLU, or any other tax-status-programmable item ([**DOLL DISC**], [**%-**], [**%+**], [**VND CPN**], [**STR CPN**]). The taxable status is reversed to non-taxable, and vice versa. The [**GST/M**] key installed only for CA version operates the same to reverse from the GST taxable status to non-taxable, and vice versa, of the required item.

## SUBTOTAL READ

--- → [ST] → --- The sale total of the items so far entered is displayed and printed.

SAMPLE OPERATION CONTENTS	KEY OPERATION	DISPLAY																			
		PLU		AMOUNT																	
		QTY	RPT	SL	AL	RE	(-)	TX	ST	TL	CG	SH									
Sale items have been entered. You want to know the subtotal here.	[ST] <div style="border: 1px solid black; padding: 5px; margin-top: 10px; width: fit-content;">                         SUBTL      \$6.00                     </div>								▼					▼		▼			6	6	3

**NOTE :** The displayed amount is the sale total including tax dues. However, the printed amount includes no tax due.

## TAX EXEMPT (The [GST/M] key is applied for the CA version only.)

### Selective Tax Exemption

- → [TX1/M] [EX] → Sales Finalization (to exempt Tax 1 only)
- → [TX2/M] [EX] → Sales Finalization (to exempt Tax 2 only)
- → [GST/M] [EX] → Sales Finalization (to exempt GST only)

### All Tax Exemption

- → [EX] → Sales Finalization (to exempt all taxes)
- → [TX1/M] [TX2/M] ([GST/M])[EX] → Sales Finalization (to exempt all taxes)

- NOTES :**
1. On depressing [EX], the sale total excluding the exempted-tax(es) is displayed, and the pre-taxed amount of the sale portion subject to the tax exemption is printed.
  2. Tax exemption is not available when the feature of value added tax is selected for GST.

SAMPLE OPERATION CONTENTS	KEY OPERATION	DISPLAY																			
		PLU		AMOUNT																	
		DPT	RPT	SL	AL	RE	( )	TZ	ST	TL	OG	SH									
Sale items have been entered.																					
You want to know the sale total including tax.	[ST]																		7	5	3
You must exempt tax from this sale for some reason	[EX]																		6	7	0
Finalized as cash sale.	[AT/TL]																		6	7	0

SUBTL	\$6.70
TAX1EX	\$6.70
TAX2EX	\$3.20
CASH	\$ 6 . 7 0
JONES	0031 15:14

## SALE FINALIZATION BY MEDIA KEYS

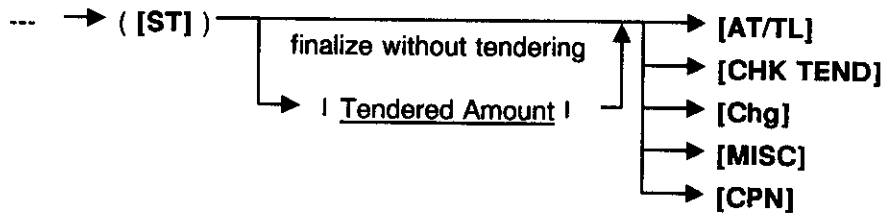

- NOTES :**
- Whether each Media Key is depressed with a prior tendered amount entry or not is determined by the key status selections programmed for each media key.
  - If the sale total is zero or negative, any media key must be depressed without a tender amount entry even if the key is programmed as "Tender" key.

SAMPLE OPERATION CONTENTS	KEY OPERATION	DISPLAY															
		PLU		AMOUNT													
		DPT	RPT	TL	ST	TL	CG	SH	TL	ST	TL	CG	SH				
<b>Cash Tender</b> Sale items have been entered.  The customer wants to know the sale total.  The customer tenders \$10.00 cash.  The change of \$3.77 is displayed. Pay it back to the customer in cash.	[ST]   1000   [AT/TL]																
<b>Charge Sales Total</b> Sale items have been entered.  The customer wants to use his credit account. You enter his Customer Account No. 1001 as reference.	[ST]  1001 [#]  [Chg]																

SUBTL	\$6.50
TAX	\$0.53
TOTAL	\$ 7 . 0 3
CATEND	\$10.00
CHANGE	\$2.97
JONES	0032 15:16

SUBTL	\$6.00
#1001	
TAX	\$0.60
Chg	\$ 6 . 6 0
JONES	0033 15:18

## MULTI-TENDER (Short-tender repeated by the same media)

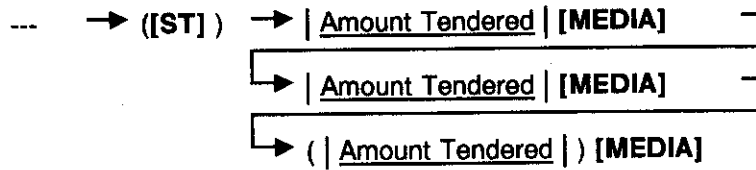

**NOTE :** In MULTI-TENDER operation, the sale is finalized and the drawer opens on reaching the sale total amount.

SAMPLE OPERATION CONTENTS	KEY OPERATION	DISPLAY									
		PLU			AMOUNT						
		DPT	RPT		TX	ST	TL	CG	SH		
SL	AL	RE									
<p>Sale items have been entered.</p> <p>The customer first tenders \$5.00 cash, which is short. (The balance still due is displayed)</p> <p>The customer then tenders another \$5.00 in cash.</p> <p>The sale is now over-tendered, finalized, and change computed. Give the change to the customer in cash.</p>	500						5.00				
	[AT/TL]						1.29				
	500						5.00				
	[AT/TL]						3.71				

TOTAL	\$ 6 . 2 9
CATEND	\$ 5 . 0 0
CATEND	\$ 5 . 0 0
CHANGE	\$ 3 . 7 1
JONES	0034 15:20

### SPLIT-TENDER (Short-tender repeated by different media)

Example 1)

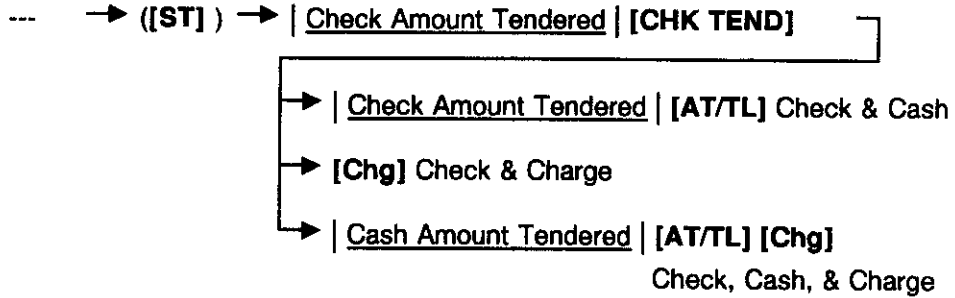

Example 2)

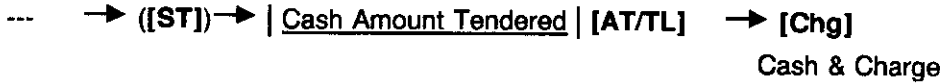

SAMPLE OPERATION CONTENTS	KEY OPERATION	DISPLAY							
		PLU		AMOUNT					
		DPT	RPT	TX	ST	TL	CG	BT	
<b>Check &amp; Cash</b> Sale items have been entered. The customer first tenders a \$10.00 check. (The balance due is displayed.) The balance is paid in cash, tendering \$5.00. Give the change in cash to the customer.	1000				1	0	0	0	
	[CHK TEND]		▼				0	4	8
	500		▼			5	0	0	
	[AT/TL]		▼				4	5	2
				▼					▼
<b>Cash &amp; Charge</b> Sale items have been entered. The customer first tenders \$10.00, which is short. (The balance due is displayed.) The customer asks to make the rest balance as his charge account.	1000				1	0	0	0	
	[AT/TL]		▼				3	3	5
	[Chg]		▼				3	3	5

TOTAL	\$ 1 0 . 4 8
CHECK	\$10.00
CATEND	\$5.00
CHANGE	\$4.52
JONES 0035 15:23	

TOTAL	\$ 1 3 . 3 5
CATEND	\$10.00
Chg	\$3.35
JONES 0036 15:25	



# CHECK CASHING (No-sale cashing of non-cash media; allowed outside a sale only.)

| Check Amount to be Cashed | [CHK TEND] ..... The drawer opens to enable the exchange.

**NOTE :** Other non-cash media keys may be used for this purpose if programmed to allow no-purchase cashing.

SAMPLE OPERATION CONTENTS	KEY OPERATION	DISPLAY									
		PLU			AMOUNT						
		DPT	RPT		TX	ST	TL	CG	SR		
A customer asks the store to cash a check of amount \$10.00 without relating to a sale.  The drawer opens. Receive the check and give \$10.00 cash out of the drawer to the customer.	1000  [CHK TEND]										1 0 0 0
											1 0 0 0
											▼

TEC STORE  
1343 PEACH DRIVE  
PHONE: 87-6437  
  
Thank you  
Call again  
  
11-20-91 #3001  
  
CHECK \$ 1 0 . 0 0  
  
JONES 0037 15:28

## SALE PAID IN FOREIGN CURRENCIES

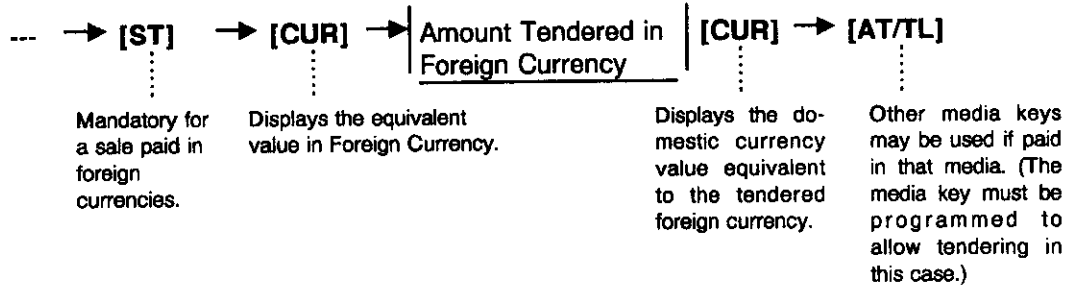

- NOTES:**
1. When a tendering by a foreign currency occurs during a short tendered condition, the [ST] key will not be mandatory.
  2. The sale is finalized if over-tendered, with change due displayed in the domestic currency. If short-tendered, the balance due is displayed in the domestic currency value.
  3. A sale of negative balance cannot be finalized using any of the foreign currency keys.

SAMPLE OPERATION CONTENTS	KEY OPERATION	DISPLAY																												
		PLU		AMOUNT																										
		DPT	RPT	SL	AL	RE	( )	Tx	ST	TL	CO	BR																		
Sale items have been entered.																														
Obtain subtotal.	[ST]																													
The customer wants to pay in Foreign Currency. (Reading the displayed amount in CUR, you tell the amount to the customer.)	[CUR] (The CUR value equipment to the above subtotal amount is displayed.)																													
The customer tenders an amount of F50.00 in CUR.	5000 [CUR] (The amount tendered is displayed in the domestic currency.)																													
Since paid in cash, use [AT/TL].	[AT/TL]																													
The sale is over-tendered and finalized. Give the change (displayed in the domestic currency value) to the customer in the domestic currency.	<table border="1"> <tr><td>SUBTL</td><td>\$7.70</td></tr> <tr><td>TAX</td><td>\$0.68</td></tr> <tr><td>TOTAL</td><td>\$ 8 . 3 8</td></tr> <tr><td>CATEND</td><td>\$9.31</td></tr> <tr><td>CHANGE</td><td>\$0.93</td></tr> </table> <p>JONES      0038 15:29</p>	SUBTL	\$7.70	TAX	\$0.68	TOTAL	\$ 8 . 3 8	CATEND	\$9.31	CHANGE	\$0.93																			
SUBTL	\$7.70																													
TAX	\$0.68																													
TOTAL	\$ 8 . 3 8																													
CATEND	\$9.31																													
CHANGE	\$0.93																													

# NO-SALE EXCHANGE FROM A FOREIGN CURRENCY TO THE DOMESTIC CURRENCY (Allowed outside a sale only)

[CUR] | Amount of foreign currency to be exchanged | [NS]

Display the zero-suppress form of CUR.

SAMPLE OPERATION CONTENTS	KEY OPERATION	DISPLAY										
		PLU		AMOUNT								
		DPT	RPT	SL	AL	RE	(-)	TX	ST	TL	CG	SH
<p>The customer asks the store to exchange his foreign currency of amount F100.00 into the domestic currency, with no purchase.</p> <p>The drawer opens.</p> <p>Receive the foreign currency, and give the amount of \$18.61 in the domestic currency out of the drawer.</p>	[CUR]									0	0	0
	10000							1	0	0	0	0
	[NS]							1	8	6	1	

TEC STORE  
 1343 PEACH DRIVE  
 PHONE: 87-6437

Thank you      Call again

11-20-91 #3001

CUR1            100.00  
 CHANGE        \$18.61

JONES           0040 15:33

**RECEIPT POST-ISSUE (Allowed outside a sale)**

A sale is finalized → **[RECEIPT ISSUE]**

- NOTES :** 1. *The post-issue receipt is not available for Received-on-Account, or Paid-Out transactions.*
2. *Post-issue receipt is itemized receipt for a sale of maximum 30 lines. However, when sale contents exceed 30 lines, the post-issue receipt is total-only receipt shown below.*

<b>T E C   S T O R E</b>	
1343 PEACH DRIVE	
PHONE: 87-6437	
Thank you	
Call again	
11-20-91 #3001	
TOTAL	<b>\$ 2 0 . 4 5</b>
JONES	0046 19:26

# VALIDATION PRINT

After entering the required item through a transaction key or a media key.

→ Insert a validation slip into the validation slot. Make sure that the "SLP" trimark is steadily lit. → [VALI DATE]

**NOTES :** 1. No other operations can follow until the validation slip once printed is withdrawn.

2. The following are programmable selections relating to validation :

(1) PRINT FORMAT

- a) Consecutive No. Print/Non-Print
- b) Clerk ID Print/Non-Print

(2) MULTI- or SINGLE-VALIDATION  
(Number of times of validation print allowed for the same item.)

(3) VALIDATION COMPULSORY status on transaction keys.

(4) When the sale-finalizing media key is programmed with Validation Compulsory status, the drawer will open after the compulsory validation print.

## RECEIPT SAMPLE

```

TEC STORE
1343 PEACH DRIVE
PHONE: 87-6437

Thank you      Call again

11-20-91  #3001

COFFEE      $2.50 T
MILK       $1.50 T
#3240
TAX        $0.48
Chg       $ 4 . 4 8

JONES      0047 19:35
    
```

## VALIDATION PRINT

```

11-20-91 0047    COFFEE    $2.50 T
-----
11-20-91 0047    MILK      $1.50 T
-----
11-20-91 0047    #3240
-----
11-20-91 0047    Chg      $ 4 . 4 8
    
```

## OTHER INCOME ENTRY

Used to enter items which do not directly become sales for the store, such as lottery, postage, gift wrapping fee, size adjustment fee, utility (payment of electricity and gas), and donation.

SAMPLE OPERATION CONTENTS	KEY OPERATION	DISPLAY											
		PLU		AMOUNT									
		DPT	RPT	SI	AL	RE	( )	TX	ST	TL	CG	SK	
A customer comes up to buy a gift of \$50.00 for Dept. 3.	5000									5	0	0	0
	[DEPT 3]	0	3			▼		▼		5	0	0	0
Then he asks the cashier to wrap the gift. (Dept. 9 is preset as an other income dept)	200					▼					2	0	0
	[DEPT 9]	0	9			▼		▼			2	0	0
	[AT/TL]									5	9	7	0

**TEC STORE**  
 1343 PEACH DRIVE  
 PHONE: 87-6437  
  
 Thank you      Call again  
  
 11-20-91 #3001  
  
 MILK            \$50.00 T  
 D P 09        \$2.00 T  
 TAX            \$7.70  
 CASH         \$ 5 9 . 7 0  
  
 JONES        0048 19:40

# ALL VOID (CANCEL)

--- → [ALL VOID] [ITEM CORR]

- NOTES:**
1. Pressing the [ALL VOID] key, followed by the [C] key will result in all void cancellation.
  2. It is inoperable if 21 items or more are entered.

SAMPLE OPERATION CONTENTS	KEY OPERATION	DISPLAY									
		PLU			AMOUNT						
		DPT	RPT		TX	ST	TL	CG	SH		
SL	AL	RE	(-)								
Sale items have been entered.  The customer asks the clerk to cancel the all sale items for some reason.	[ST]						1	3	3	5	
	[ALL VOID]			▼			▼				
	[ITEM CORR]			▼				0	0	0	
								0	0	0	

```

SUBTL      $12.00
SUBTL      $ 1 2 . 0 0

  * A L L V O I D *

JONES      0051 14:20
    
```

# VENDOR COUPON

--- → | Coupon Amount |[VND CPN] → ---

**NOTE:** The coupon amount to be entered must not exceed the sale total unless the "Credit Balance" option is selected.

SAMPLE OPERATION CONTENTS	KEY OPERATION	DISPLAY											
		PLU		AMOUNT									
		DPT	RPT	SL	AL	RE (-)	TX	ST	TL	CG	SH		
During a sale, a vendor coupon of \$4.00 is received from the customer.	[ST]									8	5	7	
	400					▼		▼	▼		4	0	0
	[VND CPN]					▼					4	0	0
						▼	▼						
		<div style="border: 1px solid black; padding: 5px; width: fit-content;">                     SUBTL            \$7.80                      V.CPN            \$4.00-                 </div>											



# STORE COUPON

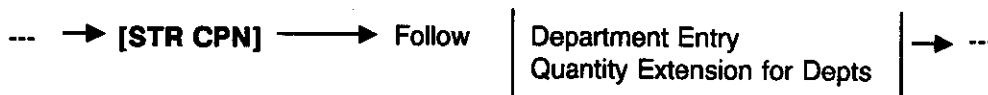

**NOTE:** The store coupon amount to be entered must not exceed the sale total unless the "Credit Balance" option is selected.

SAMPLE OPERATION CONTENTS	KEY OPERATION	DISPLAY										
		PLU			AMOUNT							
		DPT	RPT		TX	ST	TL	CG	EH			
During a sale, a store coupon of \$2.00 is received from the customer. (Dept. 6 (MEAT) is used to enter the store coupon in this example. In this operation, Dept. 6 is an open department.)	[STR CPN]									0	0	0
	200			▼						2	0	0
	[DEPT 6]	0	6	▼						2	0	0
				▼	▼							
	<div style="border: 1px solid black; padding: 5px; width: fit-content;">             S.CPN              MEAT            \$2.00-           </div>											

# ENTRY IN THE "☐" (NEGATIVE) Mode (Mode Lock : ☐)

When several items are returned at a time, turn the Mode Lock to the ☐ position using MA key which is kept by the store manager. Then enter each item just in the normal registering operation made in the "REG" mode. The ☐ position of the Mode Lock process the entered items exactly in the reverse way, i.e., positive items into negative, and negative into positive.

## OPERATION AND RECEIPT SAMPLE

RECEIPT ISSUED IN "REG" or "MGR" MODE

```

TEC STORE
1343 PEACH DRIVE
PHONE: 87-6437

Thank you          Call again

11-20-91 #3001

COFFEE           $2.50 T
      2X          2.500
CAKE              $5.00 T
BOOK              $1.50 T
ORANGE           $2.00 T
TAX               $0.93
CASH             $ 1 1 . 9 3

JONES           0055 14:37

```

These two receipt contain the same sale items and media finalization. The operations are also the same except the Mode Lock position.

The cashier merely follows the purchase receipt (on the left) and enters the same items in the ☐ position, finalizing with the same media, in case a customer has returned or canceled the entire sale after the cashier had finalized that sale.

The ☐ mode header (\* REG-) is printed at the top and the bottom of the sale contents in the ☐ mode receipt.

RECEIPT ISSUED IN "☐" MODE

```

TEC STORE
1343 PEACH DRIVE
PHONE: 87-6437

Thank you          Call again

11-20-91 #3001

* REG -
COFFEE           $2.50 T
      2X          2.500
CAKE              $5.00 T
BOOK              $1.50 T
ORANGE           $2.00 T
TAX               $0.93
CASH             $ 1 1 . 9 3

* REG -
JONES           0057 15:20

```

## 9. POWER FAILURE PROCESS

If a power failure occurs, the sales memory is protected by the back-up battery; registration and printing will normally be performed on regaining the power.

ECR CONDITION at the time of POWER FAILURE		DISPLAY INDICATION on the POWER RECOVERY
OUTSIDE A SALE	No key-in has been operated.	"0" display.
	Numeric or Declaration keys have been entered but no motorized keys.	Same as above.
DURING A SALE	No Numeric or Declaration keys have been entered.	Regains the display content that was obtained just before the power failure.
	Numeric or Declaration keys have been entered.	Same as above.

In the event of a power failure, it is suggested to check the receipt print content before the receipt is handed to the customer.

## 10. JOURNAL AND RECEIPT PAPER-END DETECTOR

- (1) This detects when either the journal or receipt paper is running out. It is provided to prompt the operator to replace the old paper roll with a new one.
- (2) When the paper roll is running out (or the paper has not been set properly), no key operation is accepted and the AMOUNT portion of the display keeps flickering.
- (3) When a new paper roll is set, only the [RF] and [JF] keys are allowed to operate. Next, when the [C] key is depressed, the display flickering will be cleared and normal key-in operations will be accepted. When any printing has been suspended, it will continue printing.
- (4) If this detector senses a paper-end condition during printing, the printing stops after the current line printing is completed.
- (5) If the [C] key is depressed in the paper-end condition, it is ignored. The [C] key depression will clear the display flickering only after the new paper roll is set.

**NOTE:** *This detector is not provided to a standard machine.*

## 11. ECR PRINTER MOTOR LOCK DETECTOR

- (1) This detects the printer motor lock condition caused by some trouble, such as paper jamming.
- (2) When such a condition is detected, the front display indicates "Error" and none of the keys (including [RF] and [JF]) will be accepted.
- (3) To regain the normal condition, turn the power of the ECR to OFF, remove the cause of the motor lock, and then turn the power to ON again.

## 12. READ (X) AND RESET (Z) REPORTS

The following table shows available reports and the the key operations to issue those reports. The contents of the X and Z reports are the same if both are available, except that:

- 1) Symbol X for X (read) reports, and Z for Z (reset) reports are printed as the header.
- 2) A reset count is printed near the end of a Z report (but not on X reports).
- 3) All the resettable counters and totals will be reset on a Z report issuance, while they will not be reset on an X report issuance. Therefore, X reports may be taken at any time and any number of times during the day or at the end of the day.

TABLE OF X AND Z REPORTS

REPORT NAME	MODE LOCK	KEY OPERATION	Sample Page
<u>* DAILY READ AND RESET</u>			
DAILY READ DAILY RESET (DEPARTMENT + FINANCIAL + CLERK)	X Z	] [AT/TL]	58
<u>PLU READ AND RESET</u>			
ALL PLU READ ALL PLU RESET	X Z	] [PLU]	
ZONE PLU READ ZONE PLU RESET	X Z	] <u>Zone-start PLU Code</u>   @/FOR   <u>Zone-end PLU Code</u>   [PLU]	60
<u>* CLERK READ AND RESET</u>			
INDIVIDUAL CLERK READ INDIVIDUAL CLERK RESET	X Z	With Code Entry Type:   Clerk No.   [CLERK No.] of the required clerk With Clerk Lock Type: Set the Clerk Key of the required clerk ] [AT/TL]	62
<u>HOURLY RANGE READ AND RESET</u>			
HOURLY READ HOURLY RESET	X Z	] 10 [AT/TL]	61
<u>* MEDIA-IN-DRAWER READ</u>	X	[#] (or [# /CID], [# /NS])	62

REPORT NAME	MODE LOCK	KEY OPERATION	Sample Page
* <u>GT READ AND RESET (ACCUMULATED DAILY)</u>			
GT READ	X	] 20 [AT/TL]	63
GT RESET	Z		

- NOTES :**
1. The drawer will open on the depression of the final key of the KEY OPERATION for the reports marked with “ \* ” in the table.
  2. Clerk “ON” status (Clerk Code Entry, or Clerk Key Set) is unnecessary to issue reports except CLERK READ AND RESET.
  3. Refer to the report samples on the following pages. As for the program data reading which is also available in the “ X ” mode, see the “VERIFICATION OF PROGRAMMED DATA”.

**DAILY READ or RESET REPORT**

Mode Lock : X for read  
Z for reset,  
[AT/TL].

<b>T E C S T O R E</b> 1343 PEACH DRIVE PHONE: 87-6437		
Thank you                      Call again		
11-20-91 #3001		
X		
Grand Total	<b>G T</b>	\$337.00
	<b>G S</b>	160
		\$337.00
Department Name	<b>COFFEE</b>	44
		16CU
Sales Ratio	<b>14.96%</b>	\$38.23
	<b>CAKE</b>	11
		8CU
	<b>9.98%</b>	\$25.50
	<b>MILK</b>	14
		10CU
	<b>32.99%</b>	\$84.30
	<b>VEGET.</b>	32
		14CU
	<b>13.06%</b>	\$33.39
	<b>FRUIT</b>	14
		9CU
	<b>11.78%</b>	\$30.10
	<b>MEAT</b>	4
		4CU
	<b>5.87%</b>	\$15.00
	<b>BOOK</b>	14
		8CU
	<b>9.84%</b>	\$25.15
	<b>D P 08</b>	2
		2CU
	<b>1.53%</b>	\$3.90
	<b>D P 09</b>	2
		2CU
		\$22.00
	<b>TOTAL</b>	135
		\$255.57
	<b>%+</b>	1
		\$0.40
	<b>TAX1</b>	\$21.02
	<b>TAX2</b>	\$8.48
	<b>N S 2</b>	135
		\$285.47
	<b>OTHER TL</b>	2
		\$22.00
	<b>%-</b>	2
		\$0.64
	<b>V.CPN</b>	1
		\$4.00
	<b>DISC</b>	1
		\$0.50
	<b>TOTAL</b>	37CU
		\$302.33

Gross Sale Item Count  
Amount  
Item Count  
Customer Count  
Amount

Total Count  
Amount

Percent Charge Count  
Amount

GST Amount (Add-on Tax  
Feature) is printed on CA  
model.

Net Sale without Tax Item Count  
and Amount is printed by the  
program option.

Tax Amount 1  
Tax Amount 2  
Net Sale with Tax Item Count  
Amount  
Other Income Sales Total Count  
Amount  
Percent Discount on Subtotal Count  
Amount  
Vendor Coupon Count  
Amount  
Dollar Discount Count  
Amount  
All-media Sales Customer Count  
Amount

CASH	21CU		
		\$160.80	
CHECK	4CU		
		\$44.36	
Chg	10CU		
		\$68.82	
MISC	2CU		
		\$19.35	
CPN	0CU		
		\$9.00	
R/A	3		
		\$192.50	
PO	2		
		\$7.70	
CASH ID		\$109.77	
CHECK ID	7		
		\$65.00	
MISC ID	4		
		\$20.50	
CPN ID	3		
		\$9.00	
CORR	2		
		\$9.00	
VOID	1		
		\$1.00	
ALL VD	2		
		\$22.00	
%-	1		
		\$0.10	
S.CPN	1		
		\$2.00	
RTN	1		
		\$5.00	
-TAX		\$0.50	
REG-	1		
		\$11.93	
TXBL1		\$210.18	
TXBL2		\$169.04	
TAX EX	1CU		
TAX1EX		\$6.70	
TAX2EX		\$3.20	
CUR1	3		
		1150.00	
JONES			
G S	180		
		\$337.00	
OTHER TL	2		
		\$22.00	
JONES	0066	21:19	

Cash Sales Customer Count Amount  
 Check Sales Customer Count Amount  
 Charge Sales Customer Count Amount  
 Misc. Sales Customer Count Amount  
 Coupon Sales Customer Count Amount  
 Received-on-Account Count Amount  
 Paid-Out Count Amount  
 Cash-in-drawer Amount  
 Check-in-drawer Count Amount  
 Misc. -in-drawer Count Amount  
 Coupon-in-drawer Count Amount  
 Item Correct Count Amount  
 Void Count Amount  
 All Void Count Amount  
 Percent Discount on Line Items Count Amount  
 Store Coupon Count Amount  
 Returned Merchandise Item Count Amount  
 Negative Tax Amount  
 Negative Mode (E) Count  
 Total Amount  
 Taxable Total 1  
 Taxable Total 2  
 Tax Exempted Customer Count  
 Sale Portion subject to Tax 1 Exemption  
 Sale Portion subject to Tax 2 Exemption  
 Foreign Currency 1-in-drawer Count Amount  
 Clerk Name  
 Gross Sale Item Count Amount  
 Other Income Sales Total Count Amount

GST Taxable Total (Sale Amount Portion subject to GST taxation) is printed on CA model.

GST Amount (Value added Tax Feature) is printed on CA model.

Sale Portion subject to GST Exemption is printed on CA model.

New Net Sale Amount is printed on CA model.

**ALL PLU READ or RESET REPORT**

**ZONE PLU READ or RESET REPORT**

**TEC STORE**  
 1343 PEACH DRIVE  
 PHONE: 87-6437  
 Thank you            Call again  
 11-20-91 #3001  
 X  
 005 TOMATO            26            \$19.50  
 011 PLU011            7            \$21.00  
 020 ORANGE            7            \$14.00  
 025 MOCHA            4            \$9.50  
 030 SUGAR            28            \$14.00  
 500 PLU500            8            \$15.20  
 TOTAL            80            \$93.20  
 JONES            0067 21:27

Mode Lock :  
 X for read,  
 Z for reset, [PLU]

PLU Code, Name  
 Item Count  
 Amount

Total Count  
 Amount

**TEC STORE**  
 1343 PEACH DRIVE  
 PHONE: 87-6437  
 Thank you            Call again  
 11-20-91 #3001  
 X  
 020 ORANGE            7            \$14.00  
 025 MOCHA            4            \$9.50  
 030 SUGAR            28            \$14.00  
 TOTAL            39            \$37.50  
 JONES            0068 21:28

Mode Lock :  
 X for read,  
 Z for reset,

Zone-start PLU | [ @ / FOR ] | Zone-end PLU

[PLU]

PLU Code, Name  
 Item Count  
 Amount

Total Count  
 Amount



**HOURLY READ or RESET REPORT**

Mode Lock : **X** for read  
**Z** for reset,  
10 [AT/TL].

<b>T E C S T O R E</b>	
1343 PEACH DRIVE	
PHONE: 87-8437	
Thank you	
Call again	
11-20-91 #3001	
<b>X 1 0</b>	
08:00TM	1CU
	\$5.55
12:00TM	15CU
	\$91.57
15:00TM	15CU
	\$86.25
19:00TM	6CU
	\$102.10
JONES 0069 21:28	

Up to 8:00  
No sales data is recorded.

12:00 to 15:00  
Customer Count, Sales Amount

19:00 to 24:00  
Customer Count, Sales Amount

8:00 to 12:00  
Customer Count , Sales Amount

15:00 to 19:00  
Customer Count, Sales Amount

**INDIVIDUAL CLERK READ or RESET REPORT**

Mode Lock : X for read,  
Z for reset

With Code Entry Type:  
| Clerk No. | [CLERK No.]

of the  
required clerk

With Clerk Lock Type:  
Set the Clerk Key of the  
required clerk

1[AT/TL]

```

TEC STORE
1343 PEACH DRIVE
PHONE: 87-6437

Thank you          Call again

11-20-91 #3001

          X
JONES
G S              160
                  $337.00
OTHER TL         2
                  $22.00

JONES          0071 21:30
    
```

Clerk Name  
Gross Sale Item Count  
Amount  
Other Income Sales Total Count  
Amount

**MEDIA-IN-DRAWER READ REPORT**

Mode Lock :X  
[#] (or[#/CID], [#NS])

```

TEC STORE
1343 PEACH DRIVE
PHONE: 87-6437

Thank you          Call again

11-20-91 #3001

          X
TOTAL              37CU
                  $302.33
CASH ID            $109.77
CHECK ID           7
                  $65.00
MISC ID            4
                  $20.50
CPN ID             3
                  $9.00
CUR1               3
                  1150.00

JONES          0072 21:31
    
```

All-media Sales  
Customer Count, Amount  
Cash-in-drawer Amount  
Check-in-drawer Count  
Amount  
Misc.-in-drawer Count  
Amount  
Coupon-in-drawer Count  
Amount  
Foreign Currency 1-in-drawer Count  
Amount

**GT READ or RESET REPORT**

Mode Lock : **X** for read,  
**Z** for reset,  
 20 [AT/TL]

<b>T E C S T O R E</b> 1343 PEACH DRIVE PHONE: 87-6437	
Thank you	Call again
11-20-91 #3001	
<b>G T X</b>	
<b>G T</b>	\$337.00
<b>G S</b>	160
	\$337.00
COFFEE	44
	16CU
14.96%	\$38.23
CAKE	11
	8CU
9.98%	\$25.50
MILK	14
	10CU
32.99%	\$84.30
VEGET.	32
	14CU
13.06%	\$33.39
FRUIT	14
~~~~~	
CORR	2
	\$9.00
VOID	1
	\$1.00
ALL VD	2
	\$22.00
%-	1
	\$0.10
S.CPN	1
	\$2.00
RTN	1
	\$6.00
-TAX	\$0.50
REG-	1
	\$11.93
TXBL1	\$210.18
TXBL2	\$169.04
TAX EX	1CU
TAX1EX	\$6.70
TAX2EX	\$3.20
<b>JONES</b>	
<b>G S</b>	160
	\$337.00
OTHER TL	2
	\$22.00
~~~~~	
JONES	0073 21:31

As for other GT reports, refer to the TABLE OF X AND Z REPORTS.  
 In GT reports, the contents and print formats are the same as their corresponding daily reports, except that report header is changing.

← GT Reset Report Count (Print on RESET report)

## 13.PROGRAMMING OPERATIONS

This chapter is provided for the store programmer or the store manager who may have to change the programmed data of the MA-1300 series ECR on a daily, weekly, or monthly basis. Usually, all the basic program data required for your store should be set before delivering the product by your local TEC representative. However, to change or add program data, please refer to this chapter.

### TABLE OF PROGRAMMING CONTENTS

	(Page)
-- BASIC KEY FUNCTIONS AND KEYBOARDS IN PROGRAMMING OPERATIONS-- .....	65
-- CHARACTER ENTRIES -- .....	66
STORE NAME/MESSAGE AND COMMERCIAL MESSAGE PROGRAMMING .....	70
CLERK NAME PROGRAMMING .....	73
PLU TABLE PROGRAMMING OR CHANGING .....	74
TIME SETTING OR ADJUSTMENT .....	76
DATE SETTING OR ADJUSTMENT .....	76
DEPARTMENT PRESET PRICE SETTING OR CHANGING .....	77
PLU PRESET PRICE CHANGING .....	78
% + AND %- PRESET RATE SETTING .....	79
LISTING CAPACITY SETTING FOR TENDER MEDIAS .....	80
FOREIGN CURRENCY EXCHANGE RATE SETTING .....	81
GST TAX RATE SETTING .....	83

## BASIC KEY FUNCTIONS AND KEYBOARD VARIATIONS IN PROGRAMMING OPERATIONS

### Basic Key Functions

1. The following are main keys and their functions to be used in programming operations:

- [@/FOR]** . . . . . Used to enter the program Submode No.
- [ST]** . . . . . Used to enter the Address No. or Item Code. Also used to end the item data entries.
- [#]** (or **[#NS]**) . . . . . Used to enter data for the address or item. Each character code is also entered through this key.
- [AT/TL]** . . . . . Used to end the entire program Submode sequence.

2. Functions of the **[C]** key:

- When an entered program data is already printed, the **[C]** key cannot clear it any longer. To correct the data, re-enter it.
- Before the entered data is printed, the data may be cleared by the **[C]** key.

### Keyboards in Programming operations

The MA-1300 provides two keyboards for programming operations. Depending on which keyboard is used, the key layout and the character entry method will vary.

#### Case 1: When the ECR Keyboard alone is used for programming:

Follow the instructions as they are described in this manual. For character settings, use the CHARACTER CODE TABLES (later stated). None of the DIRECT CHARACTER ENTRY methods are possible.

#### Case 2: When the Programming Keyboard TKB-1 (hardware option) is connected:

- 1) Character Keys provided on the TKB-1 keyboard may be used to directly enter the characters. (DIRECT CHARACTER ENTRY method). Any characters not provided on the TKB-1 keyboard (and those provided as well) may be entered through the Numeric Keys and the **[#]** key on the ECR keyboard, referring to the CHARACTER CODE TABLES.
- 2) Basic Function Keys (**[C]**, **[@/FOR]** (= **[X]**), **[ST]**, **[AT/TL]**) may be depressed either on the TKB-1 or the ECR keyboard. If any other keys not provided on the TKB-1 are required in programming operates, operate them on the ECR keyboard (such as Department Keys, **[PLU]**, etc.).

## CHARACTER ENTRIES

As already stated, there are two methods of operations for character settings for names or messages: CHARACTER CODE ENTRY Method and DIRECT CHARACTER ENTRY Method.

### CHARACTER CODE ENTRY Method

This method is to set a character by entering a Character Code and depressing the [#] key.

### DIRECT CHARACTER ENTRY Method

This method is to set a character by directly depressing the Character Key on the TKB-1 Keyboard:

By using those character keys, the characters are directly entered. In this manual, sample operations are attached to most of the programming operations. And at name or message programming portions, characters are entered by the CHARACTER CODE ENTRY method. Instead of this, you may depress the Character Keys. For example, instead of entering 11 [#] (to enter character "A"), you may simply depress Character Key "A" on either of the above keyboards.

On the following pages, Character Code Tables under the CHARACTER CODE ENTRY Method and the TKB-1 Keyboard under the DIRECT CHARACTER ENTRY Method are shown. These pages are to be referred to, every time the "Character Entries" sequence is contained in various programming operations in this manual.

Read through these pages at least once first, so that you may know the appropriate method of character entries using the ECR keyboard and/or option keyboard.

# Character Code Entry Method

## Character Code Table

Col Row	0	1	2	3	4	5	6	7	8	9	10	11	12	13	14	15	16	17	18
0	0	@	J	T	ア	サ	ナ	マ	ラ	ア	,	½	j	t	Ä	ä	â	(	ψ
1	1	A	K	U	イ	シ	ニ	ミ	リ	イ	.	a	k	u	Ö	ö	ê	)	Ω
2	2	B	L	V	ウ	ス	ヌ	ム	ル	ウ	:	b	l	v	Ü	ü	ç	Γ	
3	3	C	M	W	エ	セ	ネ	メ	レ	エ	'	c	m	w	Æ	æ	é	Δ	
4	4	D	N	X	オ	ソ	ノ	モ	ロ	オ	/	d	n	x	Œ	œ	è	θ	
5	5	E	O	Y	カ	タ	ハ	ヤ	ワ	ツ	#	e	o	y	Å	å	ú	Λ	
6	6	F	P	Z	キ	チ	ヒ	ユ	ヲ	ヤ	✕	f	p	z	Ñ	ñ	á	Ξ	
7	7	G	Q	\$	ク	ツ	フ	ヨ	ン	ユ	Π	g	q	+	%	β	í	π	
8	8	H	R	£	ケ	テ	ヘ	]	"	ヨ	&	h	r	φ	///	Ð	ó	Σ	
9	9	I	S	¥	コ	ト	ホ	]	°	ー	!	i	s	=	?	ð	▲	Ø	

Space

### Character Setting Operations :

- To set a regular-sized character, enter the COL (column) code and then the ROW code, followed by the [#] (or [#NS]) key.  
ex.) To set "M", enter 23, and depress [#].  
To set "%", enter 147 and depress [#].
- To set a blank instead of a character, simply depress [#] without a prior code entry, or enter 169 and depress [#].
- Depress the [ @/FOR ] key once prior to a regular-sized character entry, and it will be a double-sized character (a blank will also be double-sized).  
ex.) To set "GROUP", "G" in double-sized, and "ROUP" in regular-sized:

[ @/FOR ] 17 [#]    28 [#]    25 [#]    31 [#]    26 [#]  
 G                    R                    O                    U                    P

- Depress the [ @/FOR ] key twice prior to the first character code entry to set the entire message line or enter name with all double-sized characters.  
ex.) To set "GROUP" all in double-sized:

[ @/FOR ] [ @/FOR ]    17 [#]    28 [#]    25 [#]    31 [#]    26 [#]  
 |                                    G                    R                    O                    U                    P

All Double-sized Declaration

## Direct Character Entry Method

Using TKB-1 (Programming Keyboard; hardware option)

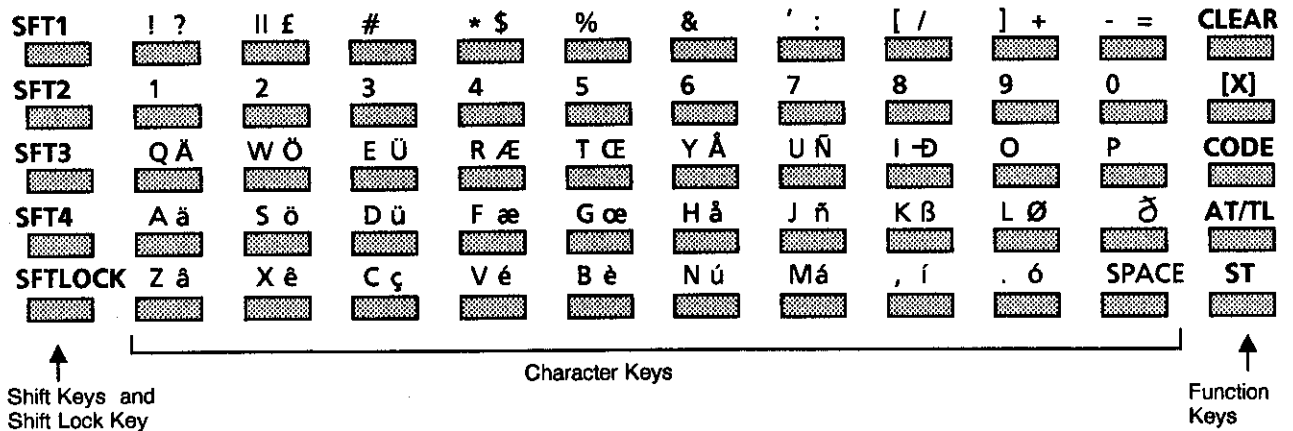

### Shift Keys (1 to 4), Shift Lock Key

Used to designate the shift of the character keys. Each character has three different characters, each of which is designated by the Shift Key 1 to Shift Key 3. (The Shift Key 4 is not used for the MA-1300 series models.)

Shift Key 2 and Shift Key 3 are effective for one following character only. After that, the Shift 1 mode is automatically regained.

### Character Keys

Used to enter alpha/numerics as characters. In setting a name or message, simply depress the corresponding character key here, instead of a character code and the [#] key combination on the ECR keyboard.

ex.)

A ä

"A" is entered in the Shift 1 mode.

Operate: ([SFT1]) → [A ä]

"a" is entered in the Shift 2 mode.

Operate: [SFT2] → [A ä]

"ä" is entered in the Shift 3 mode.

Operate: [SFT3] → [A ä]

The numeric keys [1] through [0] (on the second row from the top) are used as character keys (i.e. the entered number will be part of the name or message to be printed), but not used for code entry purpose such as for Department Codes, PLU Codes, etc.

Also note that those numeric keys may be entered in the Shift 1, 2, or 3 mode.



**Function Keys**

Except for the [CODE] key, each of the function keys corresponds to the identical key installed on the ECR keyboard as to the function in programming operations. ([CLEAR] = [C])

The [CODE] key cannot be used for the MA-1300 series ECRs.

**Operation Examples**

To set the Menu Item name "COFFEE" for Dept. 2:

ON ECR KEYBOARD ONLY

3 [@/FOR] [DEPT 2]     $\frac{13 \text{ [#]}}{C}$      $\frac{25 \text{ [#]}}{O}$      $\frac{16 \text{ [#]}}{F}$      $\frac{16 \text{ [#]}}{F}$      $\frac{15 \text{ [#]}}{E}$      $\frac{15 \text{ [#]}}{E}$   
[ST] [AT/TL]

USING TKB-1 KEYBOARD

3 [@/FOR] [DEPT 2]    C O F F E E [ST] [AT/TL]  
on ECR                                      on TKB-1

([@/FOR], [ST], and [AT/TL] may be operated on ECR or on TKB-1. Code entries such as "3" in the above example must be entered on ECR.)

The "One Double-size Declaration" (by depression [@/FOR] once prior to the required character) and the "All Double-size Declaration" (by depressing [@/FOR] twice before the entire descriptor) are the same as in setting characters on the ECR keyboard.

Any characters not listed on the TKB-1 keyboard may be entered by the code entry method on the ECR keyboard. (the characters even listed on the TKB-1 keyboard may be entered as well by that method).

## STORE NAME /MESSAGE AND COMMERCIAL MESSAGE PROGRAMMING OR CHANGING (Submode No. 1)

- CONDITION** Any time outside a sale
- OPERATION** Mode Lock: **SET**

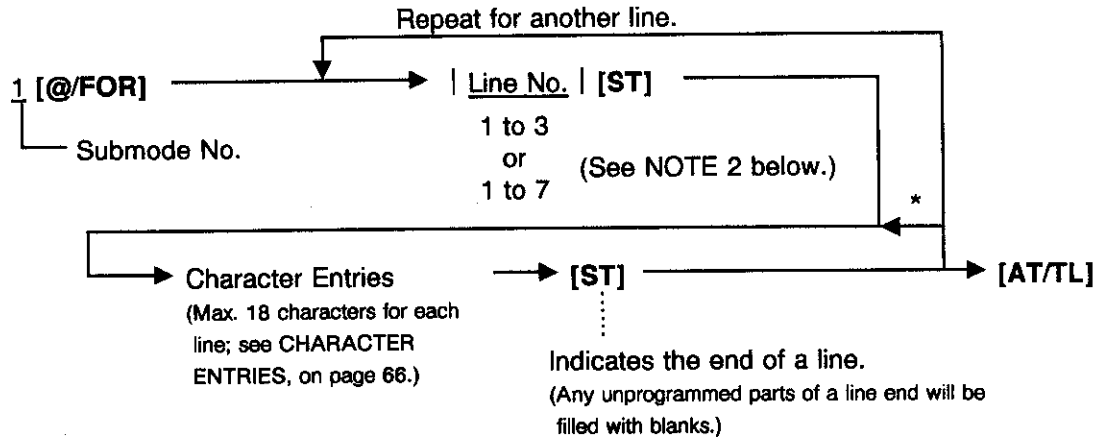

\* For sequentially programming lines, the line number specification can be skipped.

- NOTES:**
- For each line, a maximum of 18 regular-sized characters or 9 double-sized characters may be entered. A combination of both types is also available.
  - If the option "Store Name Print by RUBBER STAMP" is selected, no data can be programmed for the store name/message. Therefore, enter 1 to 3 as Line No. for the commercial message data only.  
If the option "Store Name Print by DOT PRINTER" is selected, use 1 through 4 for the store name/message and 5 through 7 for the commercial message data, as Line No.
  - If no commercial message is required on the receipt, program blanks for all three lines. As a result no extra lines will be fed. If any one of the three lines is programmed, the two other lines will cause line feeds.
  - The 4-line range assigned for the store name/message will be either printed or fed, as long as the option "Store Name print by DOT PRINTER" is selected.
  - If any incorrect characters have been programmed, depress the [C] key to clear all the characters on a line and then re-enter characters from the beginning, or end the line with an [ST] and re-program the entire line. The new data will be active.
  - When all the lines have been programmed, do a check by issuing a receipt. Only the lines with errors need to be re-programmed; other lines will not be affected.

ex.) To program the following draft as the Store Name/Message and Commercial Message  
(under the "Store Name by DOT PRINTER" option):

DRAFT:	T E C S T O R E	Line No. 1
	1   3   4   3   P E A C H   D R I V E	Line No. 2
	P H O N E :   8 7 - 6 4 3 7	Line No. 3
		Line No. 4
	T h a n k   y o u	Line No. 5
	C a l l   a g a i n	Line No. 6
		Line No. 7

**OPERATION:** Presumed that nothing has been programmed on each line.

Mode Lock to **SET**, enter 1, depress [**@/FOR**].

(The example below uses the CHARACTER CODE ENTRY method; the DIRECT CHARACTER ENTRY method will be easier if you have PROGRAMMING KEYBOARD (TKB-1).)

1 [**ST**] (Line No. 1)

[**X**] 30 [#] (T)  
 [**X**] 15 [#] (E)  
 [**X**] 13 [#] (C)  
           [#] (space)  
           [#] (space)  
 [**X**] 29 [#] (S)  
 [**X**] 30 [#] (T)  
 [**X**] 25 [#] (O)  
 [**X**] 28 [#] (R)  
 [**X**] 15 [#] (E)  
           [**ST**]

2 [**ST**] (Line No. 2)

          [#] (space)  
 01 [#] (1)  
 03 [#] (3)  
 04 [#] (4)  
 03 [#] (3)  
           [#] (space)  
 26 [#] (P)  
 15 [#] (E)  
 11 [#] (A)  
 13 [#] (C)  
 18 [#] (H)  
           [#] (space)  
 14 [#] (D)  
 28 [#] (R)  
 19 [#] (I)  
 32 [#] (V)  
 15 [#] (E)  
           [**ST**]

3 [**ST**] (Line No.)

[#] twice (space)  
           26 [#] (P)  
           18 [#] (H)  
           25 [#] (O)  
           24 [#] (N)  
           15 [#] (E)  
 102 [#] (:)  
           [#] (space)  
           08 [#] (8)  
           07 [#] (7)  
           99 [#] (-)  
           06 [#] (6)  
           04 [#] (4)  
           03 [#] (3)  
           07 [#] (7)

[**ST**]

5 [**ST**] (Line No. )

          30 [#] (T)  
           118 [#] (h)  
           111 [#] (a)  
           124 [#] (n)  
           121 [#] (k)  
           [#] (space)  
           135 [#] (y)  
           125 [#] (o)  
           131 [#] (u)

[**ST**]

6 [**ST**] (Line No. )

[#] eight times (space)  
           13 [#] (C)  
           111 [#] (a)

122 [#] (l)  
 122 [#] (l)  
           [#] (space)  
 111 [#] (a)  
 117 [#] (g)  
 111 [#] (a)  
 119 [#] (i)  
 124 [#] (n)

[**ST**]

[**AT/TL**]

10-11-91 #0
P O 1
1
T E C S T O R E
2
1343 PEACH DRIVE
3
PHONE: 87-6437
5
Thank you
6
Call again
0006 09:09

## CLERK NAME PROGRAMMING (Submode No. 2)

**CONDITION**

Any time outside a sale

**OPERATION**

Mode Lock: **SET**

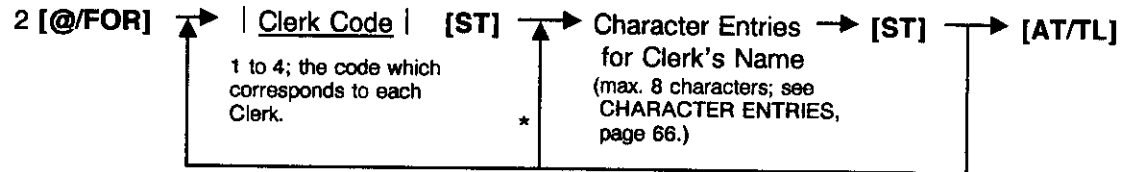

Repeat for another clerk code and name setting.

\* (When the code is sequential from the previous-set code, the Clerk Code entry may be skipped.)

- NOTES:**
1. For the name of each clerk, a maximum of 8 regular-sized or 4 double-sized characters may be entered. A combination of both types is also available.
  2. The programmed name will be printed on each receipt issued by the clerk. If no name is programmed for the clerk, the clerk ID code, such as "1CL" "2CL", etc. will be printed instead.
  3. On the validation slips, the clerk ID code (instead of the name) will be printed regardless of the name programmed here.

ex.) To program Clerk Code 1 with name "JONES",  
Clerk Code 2 with name "SMITH":

Mode Lock to **SET**, Enter 2, depress **[@/FOR]**.

Enter 1, depress **[ST]** (Clerk Code)

Enter 20, depress **[#]** (J)

Enter 25, depress **[#]** (O)

Enter 24, depress **[#]** (N)

Enter 15, depress **[#]** (E)

Enter 29, depress **[#]** (S)

Depress **[ST]** (to end Clerk 1)

Enter 2, depress **[ST]** (Clerk Code)

Enter 29, depress **[#]** (S)

Enter 23, depress **[#]** (M)

Enter 19, depress **[#]** (I)

Enter 30, depress **[#]** (T)

Enter 18, depress **[#]** (H)

Depress **[ST]** (to end Clerk 2)

Depress **[AT/TL]** to end this program.

TEC STORE	
1343 PEACH DRIVE	
PHONE: 87-6437	
Thank you	
Call again	
10-11-91 #0	
P 0 2	
1CL	JONES
2CL	SMITH
0007 09:17	

## PLU TABLE PROGRAMMING OR CHANGING (Submode No. 4)

- CONDITION**
- To program new PLUs : ] Any time outside a sale.
  - To change any programmed contents of PLUs (except the following case):
  - To change programmed contents of PLUs with sales data not zero. ] After PLU Reset.

**OPERATION** Mode Lock : SET

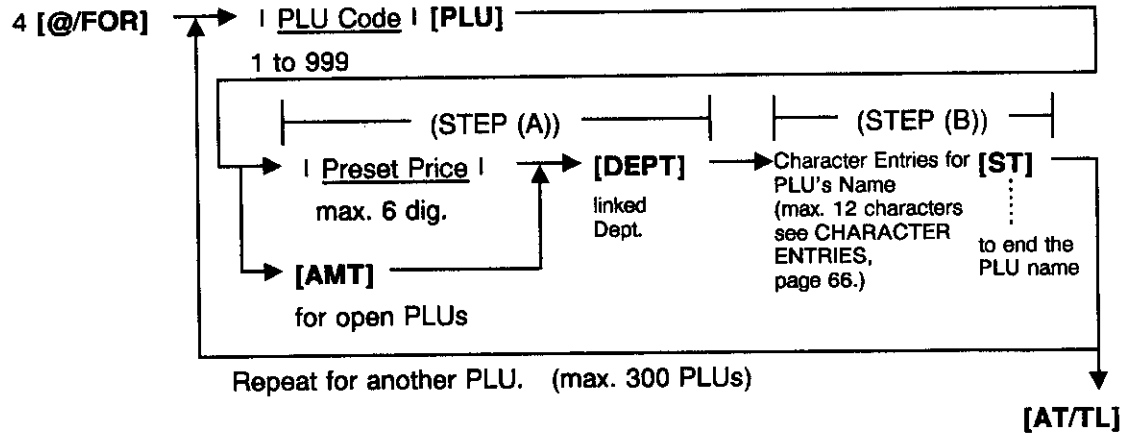

\* ' | PLU Code | [PLU]' entry may be skipped if the PLU Code is sequential from that of the PLU just set.  
 If this PLU code entry is skipped at very first PLU, the PLU code will automatically programmed as PLU No. 1.

- NOTES :**
- 1) The Positive/Negative, Single-item/Itemized, Taxable/Non-taxable status are determined by those of the department to which each PLU is linked.
  - 2) STEP (A) may be omitted if only the PLU name is set or changed. Likewise, STEP (B) may be omitted if the PLU name is not set or changed.
  - 3) If no name is set for a PLU, the PLU Code (such as "PLU 001") will be printed as the PLU name on sales receipts.
  - 4) An error results at entry time if the linked department is an other income department.

ex.) To program the following PLUs :

PLU Code	Preset Price	Linked DP	Name
PLU 5	\$1.50	04	TOMATO
PLU 11	\$3.00	03	PLU011
PLU 20	\$2.00	05	ORANGE
PLU 25	open	01	MOCHA
PLU 30	\$0.50	01	SUGAR
PLU 500	open	07	PLU500

Mode Lock to **SET**, enter 4, depress **[@/FOR]**.

5 **[PLU]** 150 **[DEPT 4]**

30 **[#]** (T) 25 **[#]** (O) 23 **[#]** (M) 11 **[#]** (A) 30 **[#]** (T) 25 **[#]** (O) **[ST]**

11 **[PLU]** 300 **[DEPT 3]**

⋮

30 **[PLU]** 50 **[DEPT 1]**

29 **[#]** (S) 31 **[#]** (U) 17 **[#]** (G) 11 **[#]** (A) 28 **[#]** (R) **[ST]**

500 **[PLU]** **[AMT]** **[DEPT 7]**

**[AT/TL]** to end this program.

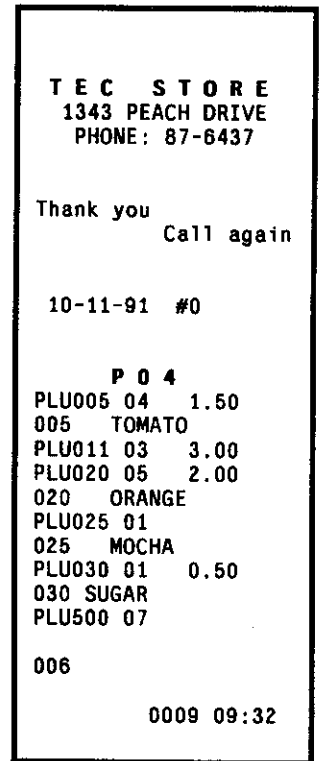

### PLU TABLE DELETION

**CONDITION**

When the sales data of the PLU is zero, or after PLU Reset

**OPERATION**

Mode Lock : **SET**

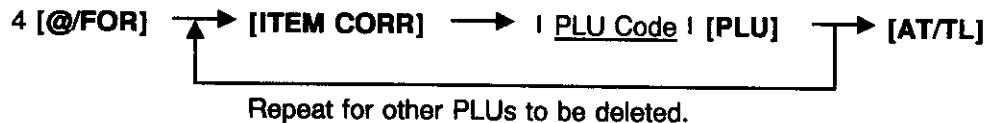

ex.) To delete PLU No. 20 once set in the above programming operation :

Mode Lock to **SET**, enter 4, depress **[@/FOR]**

Depress **[ITEM CORR]**, enter 20, depress **[PLU]**.

Depress **[AT/TL]** to end this program.

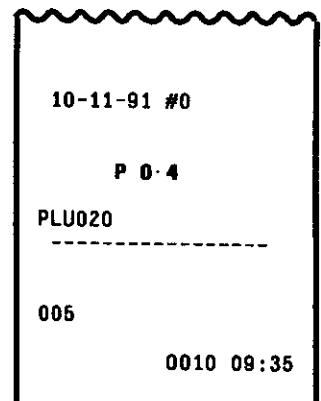

## TIME SETTING OR ADJUSTMENT (Submode 5)

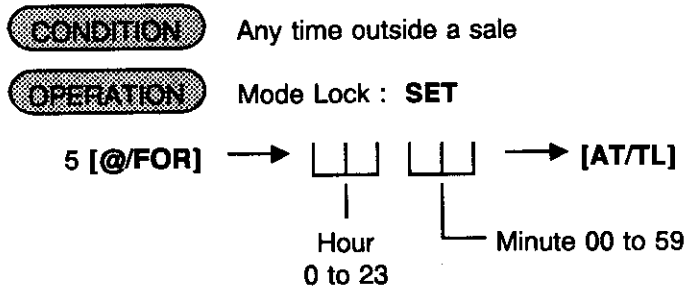

- NOTES :**
- 1) "If an hour value of more than 23 or a minute value of more than 59 is entered, no errors will result. However, in this case, set the time again with correct values.
  - 2) The date will not be changed by setting or adjusting the time.

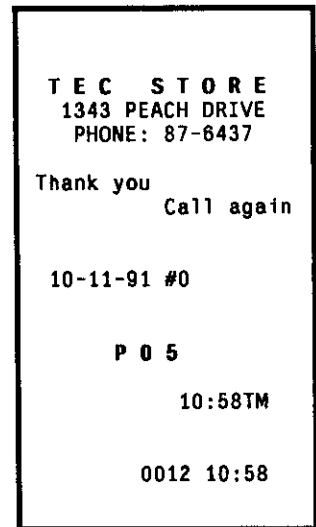

ex.) To set the time to "10:58"(10:58 a.m.)  
 Mode Lock to **SET**, enter 5, depress [**@/FOR**]  
 Enter 1 0 5 8 , depress [**AT/TL**].

## DATE SETTING OR ADJUSTMENT (Submode 6)

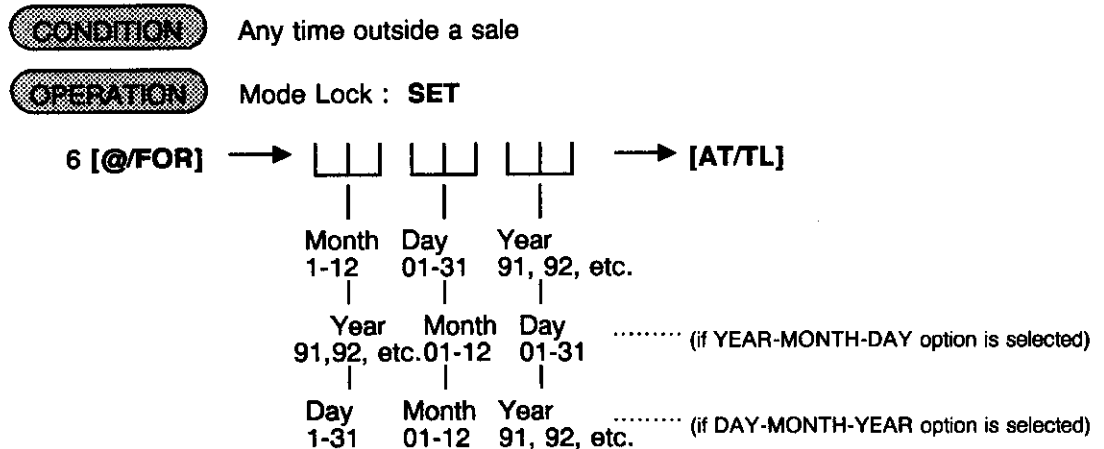

ex.) To set the date to "November 20 1991":  
 Mode Lock to **SET**, enter 6, depress [**@/FOR**]  
 Enter 1 1 2 0 9 1, depress [**AT/TL**].

**NOTE :** The extra day of a leap year is also computed automatically by the clock circuitry.

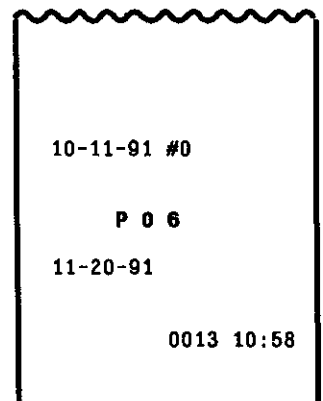



## DEPARTMENT PRESET PRICE SETTING OR CHANGING

**CONDITION**

Any time outside a sale

**OPERATION**

Mode Lock : **SET**

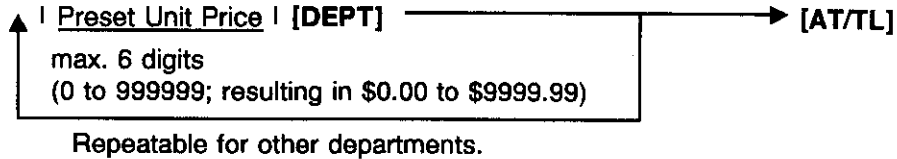

**NOTE :** When the "Preset Unit Price" is skipped and only the [DEPT] key is depressed in the above operation sequence, the department will be an open-price department (i.e. amount entry is always required before the [DEPT] key.)

ex.) To set Preset Unit Price \$2.50 to Dept. 2, and \$1.40 to Dept. 3:

Mode Lock to **SET**,  
Enter 250, depress [DEPT 2].  
Enter 140, depress [DEPT 3].  
[AT/TL] to end.

T E C S T O R E  
1343 PEACH DRIVE  
PHONE: 87-6437

Thank you                      Call again

11-20-91 #3001

P O O

02 CAKE	\$2.50
03 MILK	\$1.40

0020 11:07

ex.) To reset the Preset Unit Price (\$1.40) of Dept. 3 that was once set (i.e. to change it into an open-price department) :

Mode Lock to **SET**,  
Simply depress [DEPT 3].  
[AT/TL] to end.

P O O

03 MILK

0021 11:07

# PLU PRESET PRICE CHANGING

**CONDITION** Any time outside a sale

**OPERATION** Mode Lock : **SET**

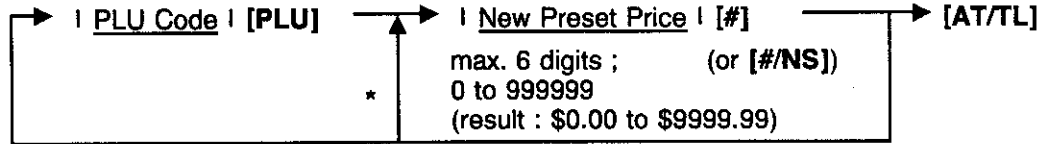

Repeatable for another PLU.

(\* Repeatable from here if the PLU Code is sequential.)

- NOTES :**
- 1) Entering 0 (zero) as New Preset Price will preset the price of \$0.00.
  - 2) In this operation, changes of the linked department or programming additional PLUs are not possible.

ex.) To change the preset price of PLU No. 5 (previously programmed with \$1.50 as the preset price) to the new price of \$0.75 :

Mode Lock to **SET**,

Enter 5, depress **[PLU]**.

Enter 75, depress **[#]**.

Depress **[AT/TL]** to end this program.

```

TEC STORE
1343 PEACH DRIVE
PHONE: 87-6437

Thank you          Call again

11-20-91 #3001

P O O
PLU005 04   $0.75
TOMATO

0022 11:08
  
```

# % + AND %- PRESET RATE SETTING

A preset rate may be set on each of the [% + ] and [%-] key, one independent rate for each key . Once a rate is preset, the % key only will be depressed without a prior rate entry to activate the preset rate. If a rate is entered prior to the depression of the key, the entered rate (manual rate) will be activated instead.

**CONDITION** Any time outside a sale

**OPERATION** Mode Lock : **SET**

| Preset % Rate | [% + ] (For Percent Charge Preset Rate)

(0.001 to 99.999(%)) ; use the [ . ] key if a decimal portion is contained.)

| Preset % Rate | [%-] (For Percent Discount Preset Rate)

ex.) To set 10% on [% + ] Key :  
Mode Lock to **SET**, enter 10, depress [% + ].

ex.) To set 5% on [%-] Key :  
Mode Lock to **SET**, enter 5, depress [%-].

To reset the rate once set:

Mode Lock: **SET**,  
Enter 0, depress the required % key.  
(Then the % key will always require a manual rate entry in sales entries.)

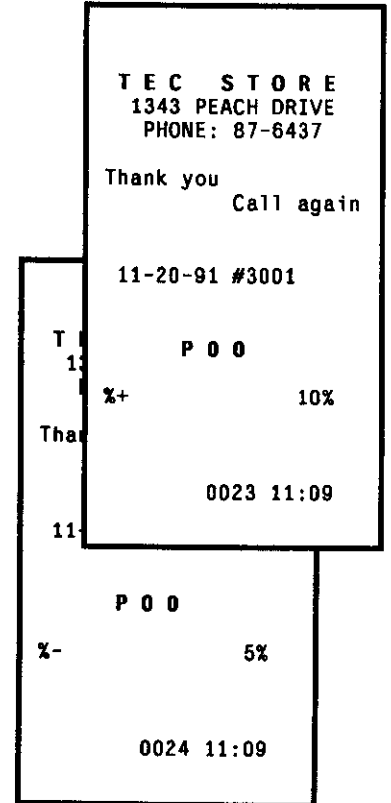

# LISTING CAPACITY SETTING FOR TENDER MEDIAS

**CONDITION** After Daily Reset

**OPERATION** Mode Lock : **SET**

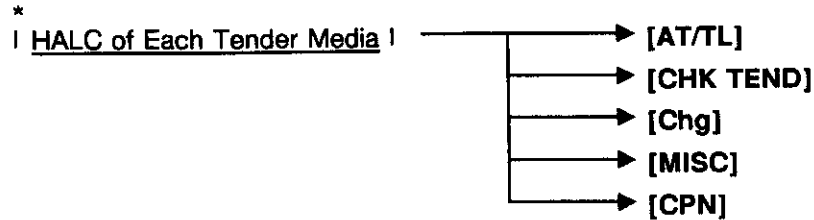

\*  
HALC ..... High Amount Listing Capacity (to be set in a 2-digit code)

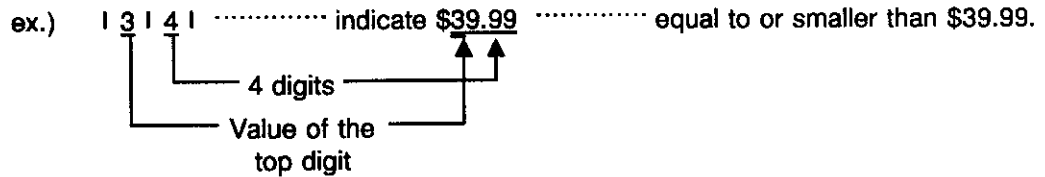

- NOTES :**
- 1) To reset an individual media listing capacity, enter 0 before media key depression in the above operation.
  - 2) The HALC of each tender media is effective only when the media key is used for tendering but not when it is used as Total key.
  - 3) The listing capacity is cleared in "MGR" mode. It cannot be cleared by the [LC OPEN] key.

ex.) To set HALCs as in the following :

<u>Table</u>	<u>Key Operation</u>
\$99.99 [AT/TL]	Mode Lock to <b>SET</b> . Enter 94, depress [AT/TL].
\$999.99 [CHK TEND]	Enter 95, depress [CHK TEND].

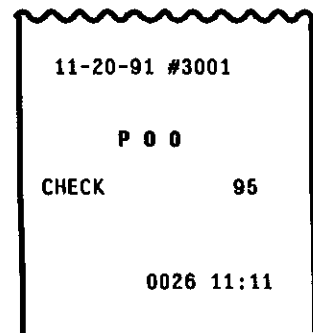
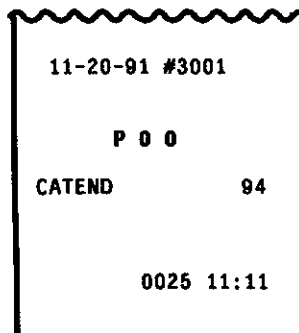

## FOREIGN CURRENCY EXCHANGE RATE SETTING

In this program, the rate of each foreign currencies (corresponding to the [CUR1] to [CUR4] keys) will be set. By setting a rate on each Foreign Currency Key, reading the sale total and tendering in the foreign currency value will be possible for sale finalization.

**CONDITION** Any time outside a sale

**OPERATION** Mode Lock : SET

| Exchange Rate for Foreign Currency 1 | → [CUR 1]

0.000001 to 9999.999999

(Use the [ . ] key if decimal portion is contained in the rate.)

⋮

| Exchange Rate for Foreign Currency 4 | → [CUR 4]

As for how to calculate the Exchange Rate, see the description below.

### Foreign Currency Exchange Rate Calculation

1. The rate must be calculated in the subsidiary currency unit values for both the domestic and the foreign currencies. (In case of calculating the rate from the domestic to a foreign currency with the same zero-suppress form, such as from U.S. \$ to French Franc, it will be no problem even if it is calculated in the main currency of \$ and Franc. However, in case of exchanging from a domestic currency such as \$ or Franc to Japanese yen or Italian Lira, or vice versa, this rule must be obeyed; otherwise a wrong rate will result.)
2. Calculate the required foreign currency value equivalent to the domestic currency value "1". Then the obtained value is the Exchange Rate value to be entered in the setting operation stated above.

For example, if the domestic currency is U.S. \$:

1¢ = xxx.xxxxx centimes (French Franc)

= xxx.xxxxx pfennigs (Deutsche Mark)

= xxx.xxxxx yen (Japanese yen)

etc.



Enter this value as each foreign currency rate.

ex.) To set three foreign currency rates:

Domestic Currency ..... U.S. \$  
Assigning: [CUR 1] ..... French Franc  
          [CUR 2] ..... Deutsche Mark  
          [CUR 3] ..... Japanese yen

Conditions given for Domestic and Foreign Currencies  
(The rates here are merely examples.)

(DOMESTIC)	(CUR 1)	(CUR 2)	(CUR 3)
U.S. dollar	French Franc	Deutsche Mark	Japanese yen
↓	↓	↓	↓
\$1.00	= Fr 5.3729	= DM1.7619	= (145.50) ..... in Main Currency Values
↓	↓	↓	↓
1 cent	= 5.3729 Centimes	= 1.7619 pfennigs	= 1.4550 ..... in Subsidiary Currency Values (Enter these values for setting.)

KEY OPERATION for setting the rates above

Mode Lock to **SET**.

- 5 [ . ] 3729 [CUR1] (for French Franc)
- 1 [ . ] 7619 [CUR2] (for Deutsche Mark)
- 1 [ . ] 4550 [CUR3] (for Japanese yen)

■ **Resetting a Foreign Currency Rate Once Set :**

Enter "0" in place of the Exchange Rate for the Foreign Currency in the setting operation. Then the rate for that foreign currency will be reset. The Foreign Currency Key of the rate thus reset cannot be used in sales entries.

TEC STORE  
1343 PEACH DRIVE  
PHONE: 87-6437

Thank you      Call again

11-20-91 #3001

P 0 0

CUR1                      5.3729\*

0031 11:16

P 0 0

CUR2                      1.7619\*

0032 11:16

1.455\*

0033 11:17

# GST TAX RATE SETTING

This setting is necessary for the CA model only.

- CONDITION** After Daily Reset
- OPERATION** Mode Lock : **SET**

| Preset GST Rate | **[GST/M]**

(0.01 to 99.99 (%); use the [ . ] key if a decimal portion is contained.)

- NOTES :**
1. To reset the rate once set, enter 0 before **[GST/M]** key depression in the above operation.
  2. A system option can provide GST taxable status to the [%] keys, the **[VND CPN]** key, the **[STR CPN]** key, or the **[DOLL DISC]** key.

ex.) To set the GST rate of 7%:  
 Mode Lock to SET,  
 Enter 7, depress **[GST/M]**

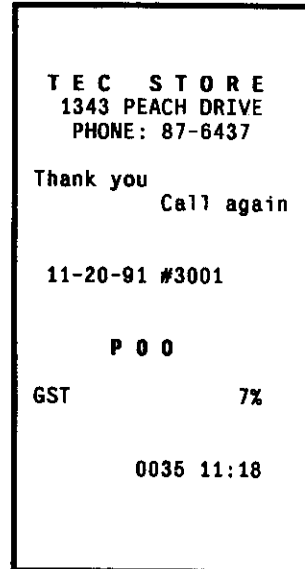

# 14. VERIFICATION OF PROGRAMMED DATA

The programmed data entered in the previous "SET" mode operations may be read for verification purposes.

**CONDITION** Any time outside a sale.

**OPERATION** Mode Lock : **X**

Follow the operation for each reading below:

(READ CONTENTS)	(KEY OPERATION)	(SAMPLE PAGE)
DEPARTMENT PRESET PRICE READ . .	1 [ST] . . . . .	85
DEPARTMENT STATUS AND LC READ .	2 [ST] . . . . .	85
PLU TABLE READ . . . . .	3 [ST] . . . . .	86
OTHER PROGRAM DATA READ . . . . .	4 [ST] . . . . .	86
USER SYSTEM OPTION READ . . . . .	5 [ST] . . . . .	87
TAX CALCULATION TEST . . . . .	<u>Entry any amount</u>   [TX1/M]	87



**DEPARTMENT PRESET PRICE READ**  
(Mode Lock : X, 1 [ST])

**DEPARTMENT STATUS AND LC READ**  
(Mode Lock : X, 2 [ST])

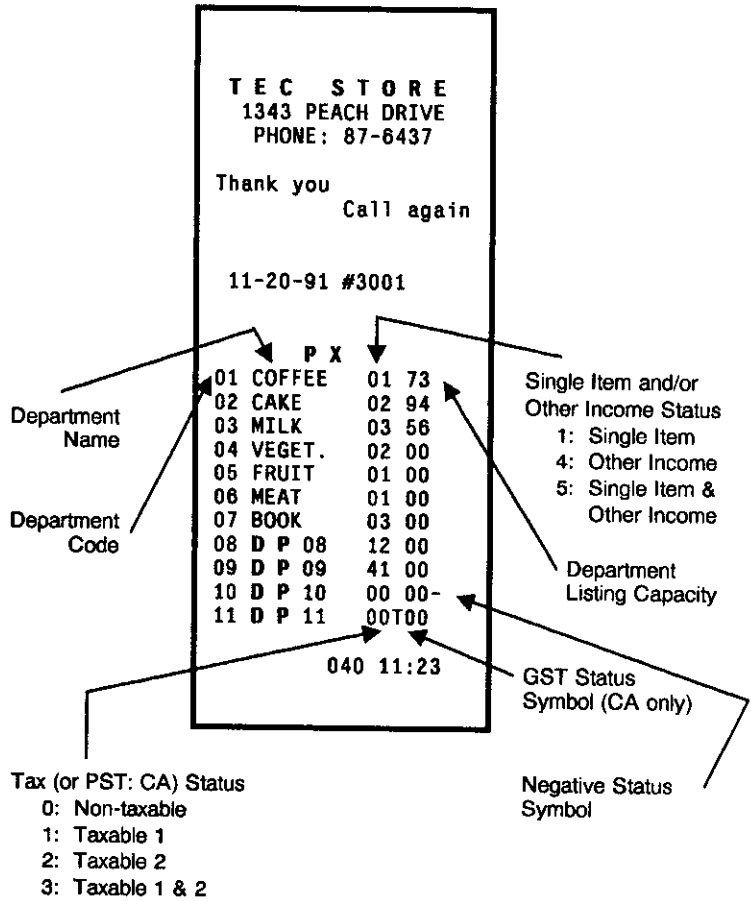
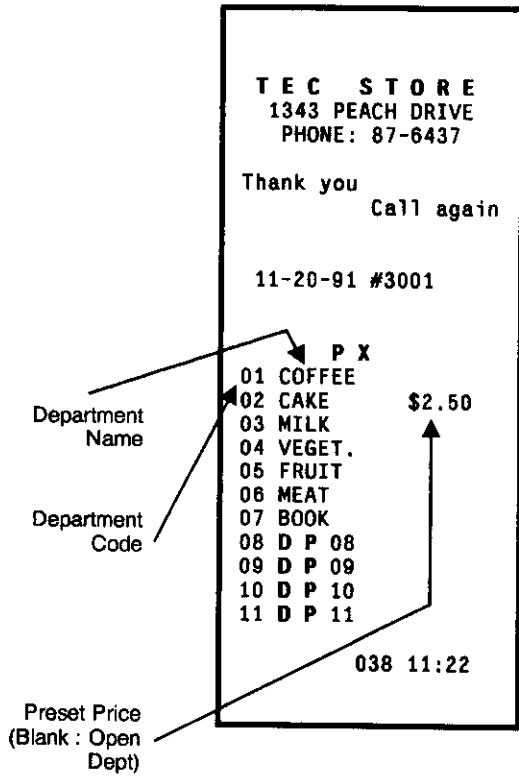

**PLU TABLE READ**  
(Mode Lock : X, 3 [ST])

**OTHER PROGRAM DATA READ**  
(Mode Lock : X, 4 [ST])

T E C S T O R E  
1343 PEACH DRIVE  
PHONE: 87-6437

Thank you                      Call again

11-20-91 #3001

	P	X				
PLU005	04		\$0.75			
TOMATO						
PLU011	03		\$3.00			
PLU011						
PLU020	05		\$2.00			
ORANGE						
PLU025	01					
MOCHA						
PLU030	01		\$0.50			
SUGAR						
PLU500	07					
PLU500						

041 11:23

PLU Code →

PLU Name →

Linked Dept Code

Preset Price (Blank : Open PLU)

T E C S T O R E  
1343 PEACH DRIVE  
PHONE: 87-6437

Thank you                      Call again

11-20-91 #3001

	P	X			
V.CPN			\$30.00		
CATEND			94		
CHEK			95		
Chg			00		
MISC			00		
CPN			00		
			86		
%+			10%		
%-			5%		
GST			7%		
			\$5.00		
CUR1			5.3729*		
CUR2			1.7619*		
CUR3			1.455*		

042 11:24

High Amount Limit for [VND CPN] key.

HALC for each Media key

Common LC for all Depts

Preset Rate for each key

GST Rate (CA only)

Non-taxable Limit Amount (CA only)

Foreign Currencies Rates

**USER SYSTEM OPTION READ  
(Mode Lock : X, 5 [ST])**

```
TEC STORE  
1343 PEACH DRIVE  
PHONE: 87-6437  
  
Thank you          Call again  
  
11-20-91 #3001  
  
P X  
#01           2678  
#02           0  
#03           0  
#04           0  
#05           0  
#06           234  
#07           167  
#08           23  
#09           235  
#10           0  
#11           345  
#12           0  
#13           123  
  
043 11:25
```

Ask your TEC representative for information of the User System Option selections for your store, if necessary.

**TAX CALCULATION TEST (Mode Lock : X)**

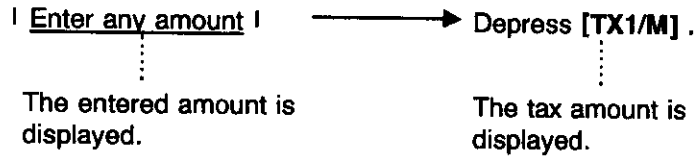

# 15. PAPER ROLL REPLACEMENT AND OTHER MAINTENANCE OPERATIONS

## 15-1 INSTALLING THE RECEIPT PAPER

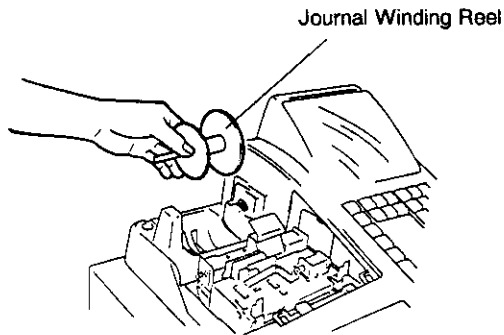

Fig. 1

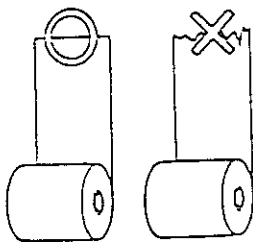

Fig. 2

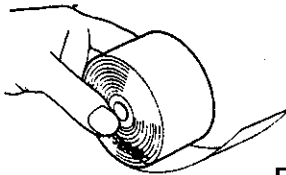

Fig. 3

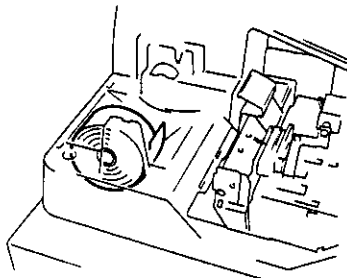

Fig. 4

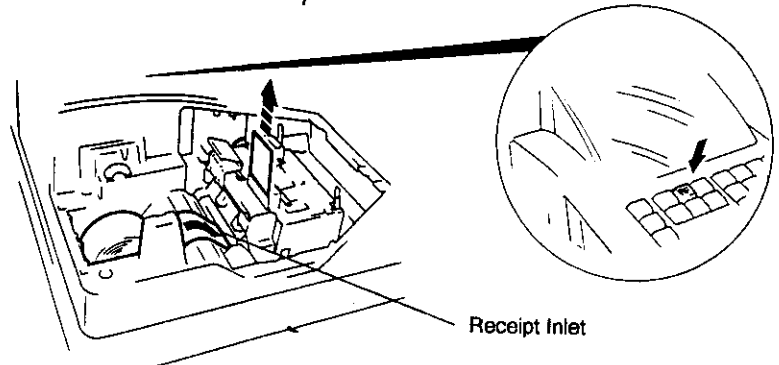

Fig. 5

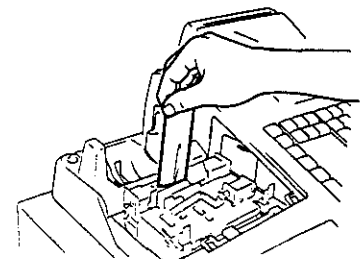

Fig. 6

1. Turn the Mode Lock to the REG position with the power ON.
2. Remove the Paper Cover, and remove the Journal Winding Reel (Fig. 1).
3. Before you install a new paper roll, the paper end should be cut with a knife or scissors for easy insertion.(Fig. 2)
4. Hold a new paper roll in the direction shown in Fig. 3 so that the paper end will be fed from the bottom.
5. Place the paper roll in the outer holder of the two roll holders (Fig. 4).
6. Insert the paper end into the Receipt Inlet, then feed the paper by pressing the [RF] key. (Fig. 5)
7. When the paper end portion comes out enough, tear off the unnecessary part with attached cutter. (Fig. 6)
8. Go on to INSTALLING THE JOURNAL PAPER steps if necessary, or go on to Step 9 below if not.
9. Attach the Paper Cover.
10. Depress the [NS] key to issue a receipt to check if the paper has been properly set.

**NOTE:** The [RF] or [JF] keys function only when both receipt and journal paper rolls have been placed in their respective holders.

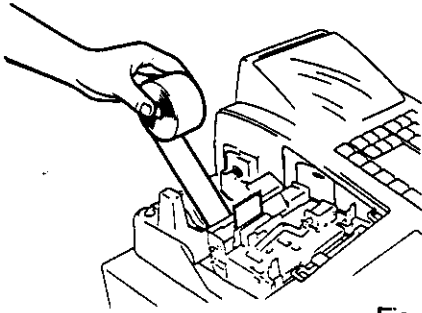

Fig. 7

## 15-2 REMOVING THE RECEIPT PAPER

1. Remove the Paper Cover.
2. Pull the paper core straight upward. (or cut the paper at the rear, then remove the remaining paper end portion by pressing the [RF] key.) (Fig. 7)

## 15-3 INSTALLING THE JOURNAL PAPER

1. Turn the Mode Lock to the REG position with the power on.
2. Remove the Paper Cover by pulling it upward, and remove the Journal Winding Reel. (Fig. 1)
3. Follow Steps 3 and 4 of INSTALLING THE RECEIPT PAPER procedure on the preceding page.
4. Place the paper roll in the inner roll holder of the two holders.
5. Insert the paper end into the Journal Inlet, then feed the paper by pressing the [JF] key. (Fig. 8)
6. When a sufficient amount of paper comes out, wind the paper around the Journal Winding Reel two or three times, and set the Journal Winding Reel into the Reel Holder. (Fig. 9)
7. Attach the Paper Cover.

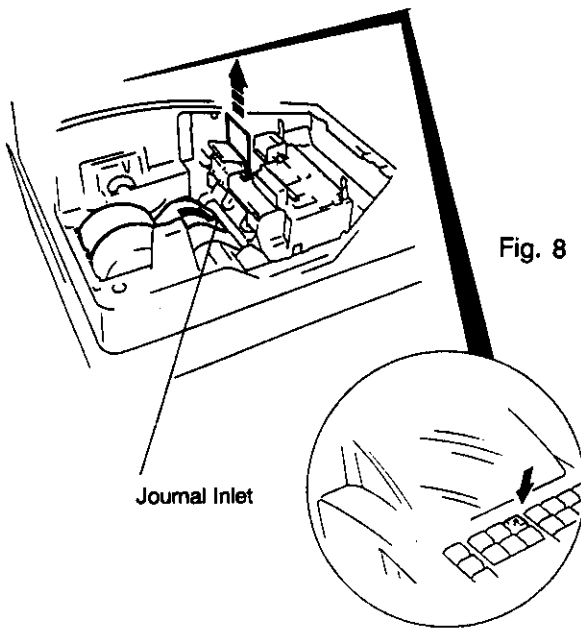

Fig. 8

Journal Inlet

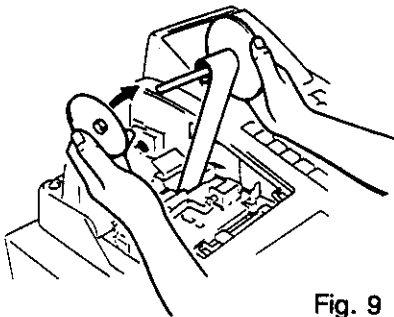

Fig. 9

## 15-4 REMOVING THE JOURNAL PAPER

1. Remove the Paper Cover.
2. Press the [JF] key to wind up enough of the journal paper, and then tear off the paper, holding the Journal Winding Reel.
3. The wound-up portion of the paper can easily be removed from the Reel by pulling it sideways. (Fig. 10)
4. If enough paper remains on the roll, follow Steps 6 and 7 above; if the paper is running out, follow Steps 1 through 7 above.

**NOTE:** The [JF] or [RF] keys function only when both journal and receipt rolls have been placed in their respective holders.

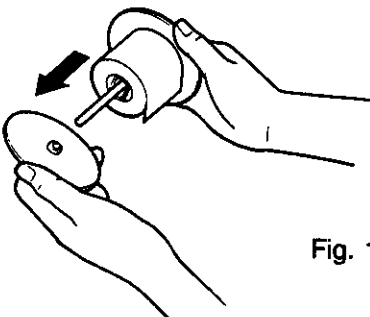

Fig. 10

## 15-5 REPLACING THE RIBBON CARTRIDGE

If either the receipt or journal print is too light, replace the Ribbon Cartridge in the following manner.

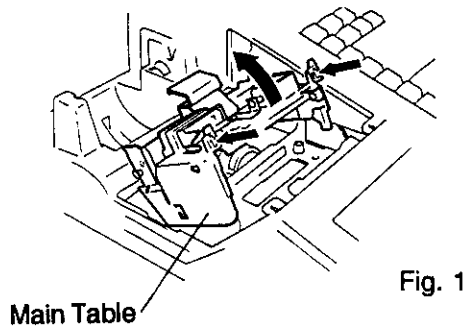

Fig. 1

1. Remove the Paper Cover .
2. Raise the Main Table with pushing the levers forward. (Fig. 1)
3. Lift up the right edge of the old Ribbon Cartridge with pushing the cartridge leftward. (Fig. 2)
4. Install a new Ribbon Cartridge in the reverse order to Step 2 above (Fig. 3).  
After setting the Ribbon Cartridge, turn the Ribbon Cartridge Knob clockwise until the slack is taken up.
5. The Ribbon Cartridge is a consumable product. Be certain to use a genuine Ribbon Cartridge supplied by your TEC representative.

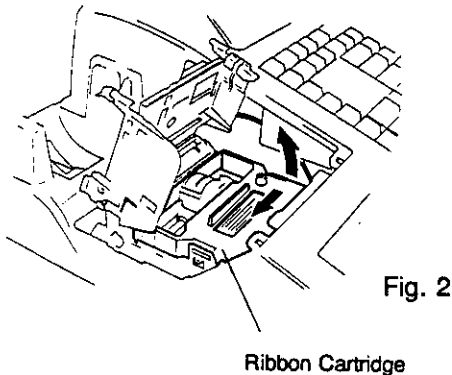

Fig. 2

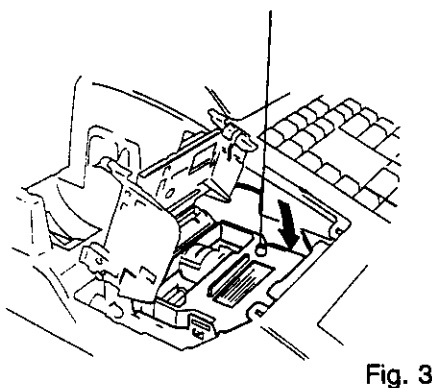

Fig. 3

## 15-6 REPLENISHING THE STORE NAME STAMP WITH INK

When the store name stamp is printed too lightly, replenish the ink in the following manner:

1. Turn the Power Switch to OFF. Remove the Paper Cover.
2. Hold the protruding part of the Store Name Stamp between your fingers, then pull it rightward. (Fig. 4)
3. Apply ink to the pad on the rear side of the Store Name Stamp. The amount applied should be adjusted according to the desired darkness of the printed message, but the limit of 2 cc should not be exceeded. (The ink bottle supplied contains 5 cc of ink.) (Fig.5)
4. Follow the reverse order of the instructions in Step 2, and then attach the cover.

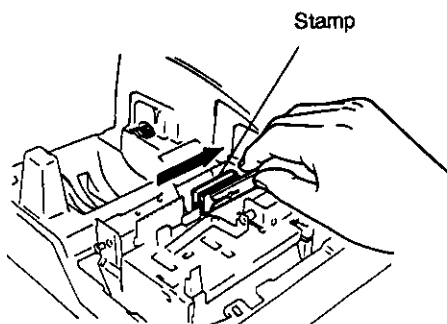

Fig. 4

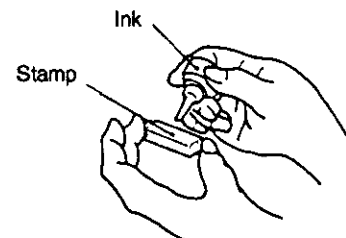

Fig. 5

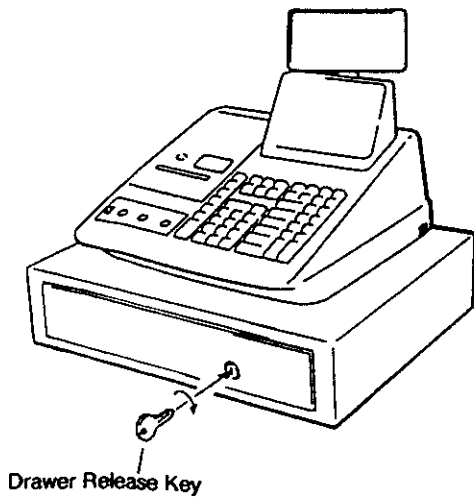

Fig. 1

## 15-7 MANUAL DRAWER RELEASING

The drawer opens automatically when a registration is performed. In the event of a power failure or other trouble, the drawer can be opened manually in the following manner:

- 1) Insert the Drawer Release Key into the drawer release lock and turn the key clockwise. The drawer will then open. (Fig. 1)
- 2) The Drawer Release Key can be taken out by returning it to the original position.
- 3) When the drawer is closed, it is automatically locked and will not open without the Drawer Release Key or a normal registering operation.

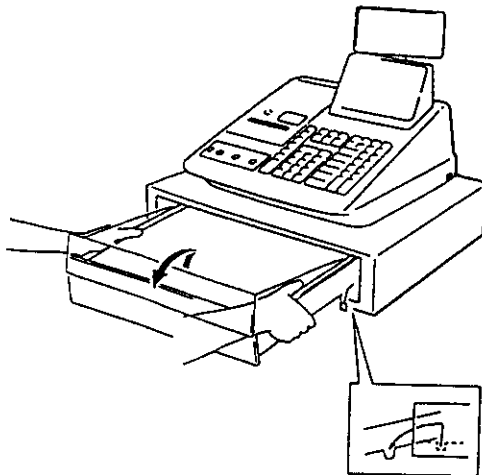

Fig. 2

## 15-8 REMOVING THE DRAWER

- 1) Pull the drawer out, and when it stops at the stopper, lift the drawer up and pull it further out (Fig. 2). When it stops again at the roller fixed in the drawer housing, lift it and pull it out (Fig. 3).
- 2) To return the drawer, follow the reverse procedure for removing.

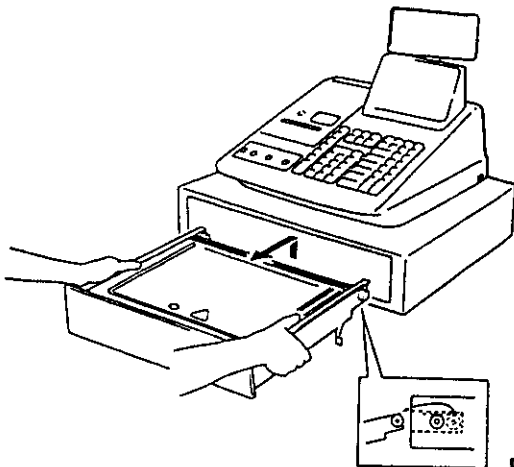

Fig. 3

## 15-9 CDC (Cash Drawer Cover) LOCK

**Locking** (Fig. 4)

- 1) Push the Cash Drawer Cover to the back of the drawer.
- 2) Press the cover lightly, insert the key into the keyhole on the cover, and turn it to lock.

**Unlocking**

- 1) Unlock the cover using the key, and lift the front end.

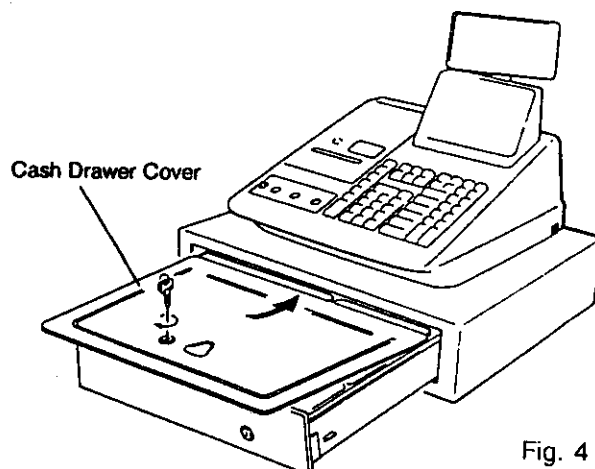

Fig. 4

## 16. SPECIFICATIONS

Size : 460mm (width) × 404mm (depth) × 319mm (height including drawer and rubber feet)  
(or 403mm-height when Customer Display is popped up.)

Weight : 16kg (with SP Drawer)

Power Required : AC 100V, 110V, 117V, 240V; 50/60Hz

Power Consumed : 0.04A (117V)

Size of Receipt and Journal : 38mm (width) × 70mm (diameter)

Ambient Temperature : 0°C to 40°C

Relative Humidity : 10% to 90%







**TEC**

**TOKYO ELECTRIC CO., LTD.**

**E** PRINTED IN JAPAN  
EO1-11084 91111000 GS